





GRAFIČKI PRILOZI

+

+

Legenda

-  drvo
-  kanta za otpatke
-  javna rasvjeta
-  hidrant na površini
-  nova zidna mreža

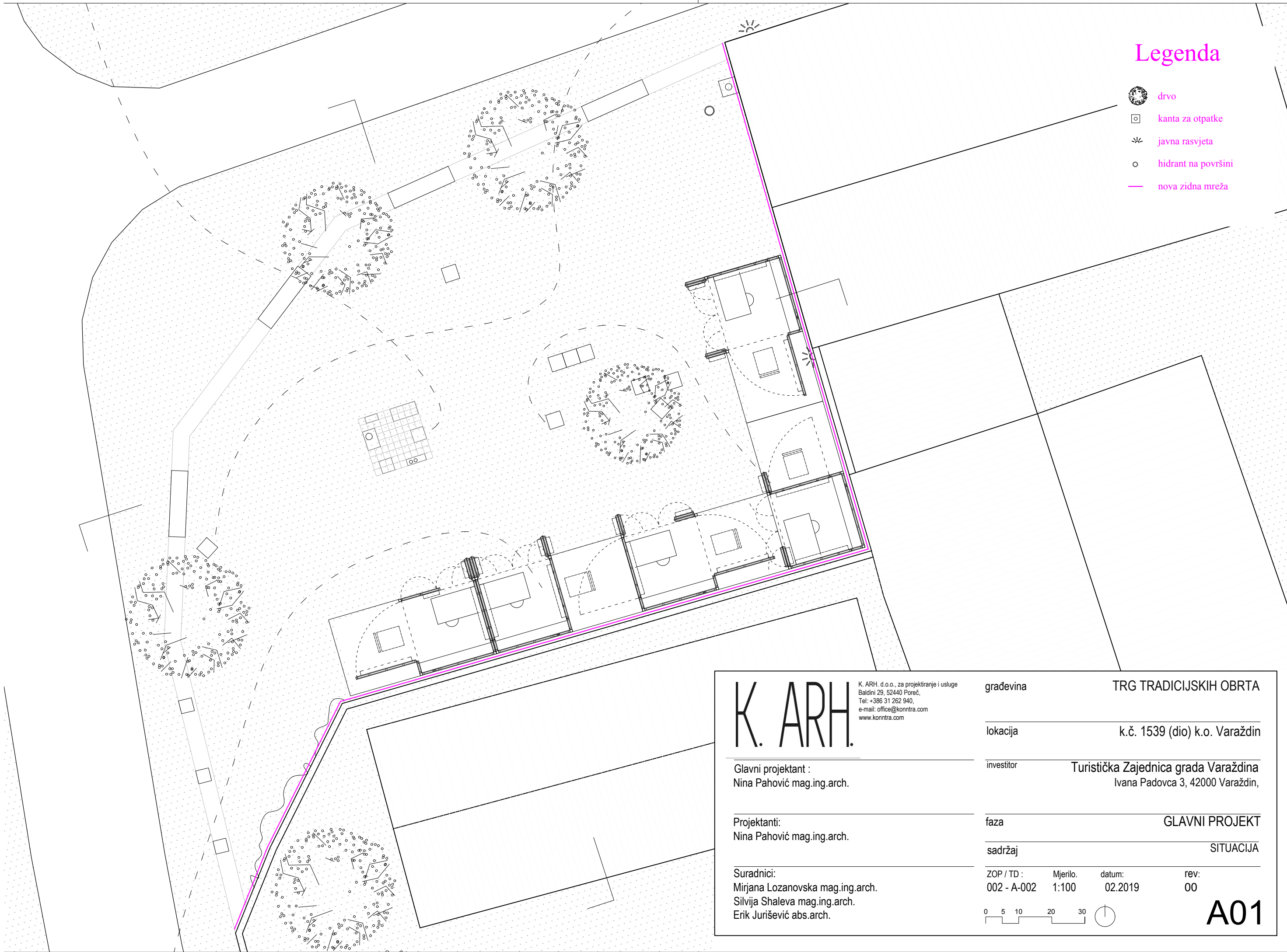

K. ARH.

K. ARH. d.o.o., za projektiranje i usluge
Baldini 29, 52440 Poreč,
Tel: +386 31 262 940,
e-mail: office@kontra.com
www.kontra.com

Glavni projektant :
Nina Pahović mag.ing.arch.

Projektanti:
Nina Pahović mag.ing.arch.

Suradnici:
Mirjana Lozanovska mag.ing.arch.
Silvija Shaleva mag.ing.arch.
Erik Jurišević abs.arch.

građevina

TRG TRADICIJSKIH OBRTA

lokacija

k.č. 1539 (dio) k.o. Varaždin

investitor

Turistička Zajednica grada Varaždina
Ivana Padovca 3, 42000 Varaždin,

faza

GLAVNI PROJEKT

sadržaj

SITUACIJA

ZOP / TD :	Mjerilo:	datum:	rev:
002 - A-002	1:100	02.2019	00

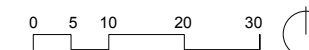

A01

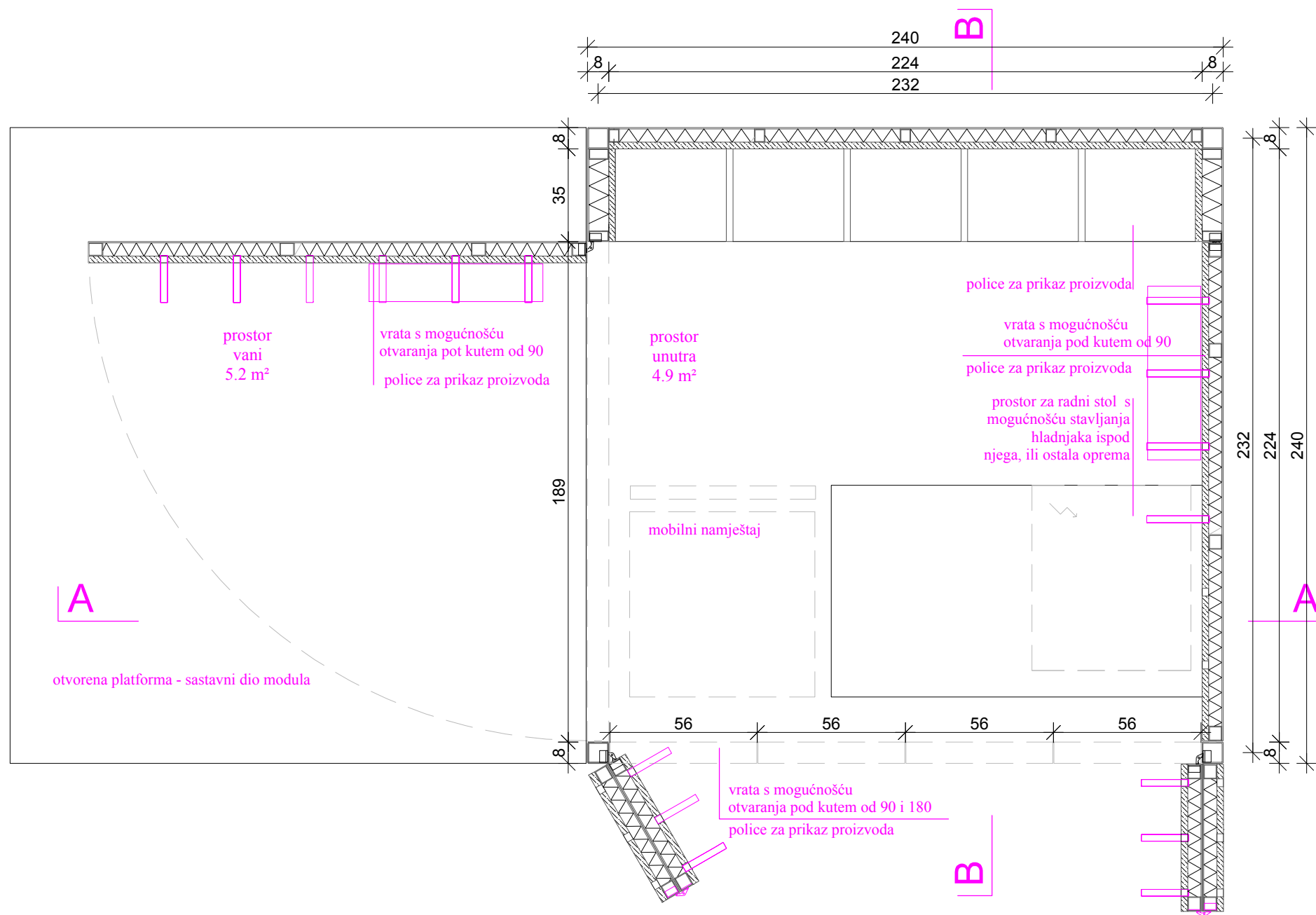

K. ARH.

K. ARH. d.o.o., za projektiranje i usluge
 Baldini 29, 52440 Poreč,
 Tel: +386 31 262 940,
 e-mail: office@kontra.com
 www.kontra.com

Glavni projektant :
 Nina Pahović mag.ing.arch.

Projektanti:
 Nina Pahović mag.ing.arch.

Suradnici:
 Mirjana Lozanovska mag.ing.arch.
 Silvija Shaleva mag.ing.arch.
 Erik Jurišević abs.arch.

građevina TRG TRADICIJSKIH OBRTA

lokacija k.č. 1539 (dio) k.o. Varaždin

investitor Turistička Zajednica grada Varaždina
 Ivana Padovca 3, 42000 Varaždin,

faza GLAVNI PROJEKT

sadržaj TLOCRT

ZOP / TD : Mjerilo. datum: rev:
 002 - A-002 1:20 02.2019 00

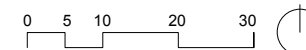

A02

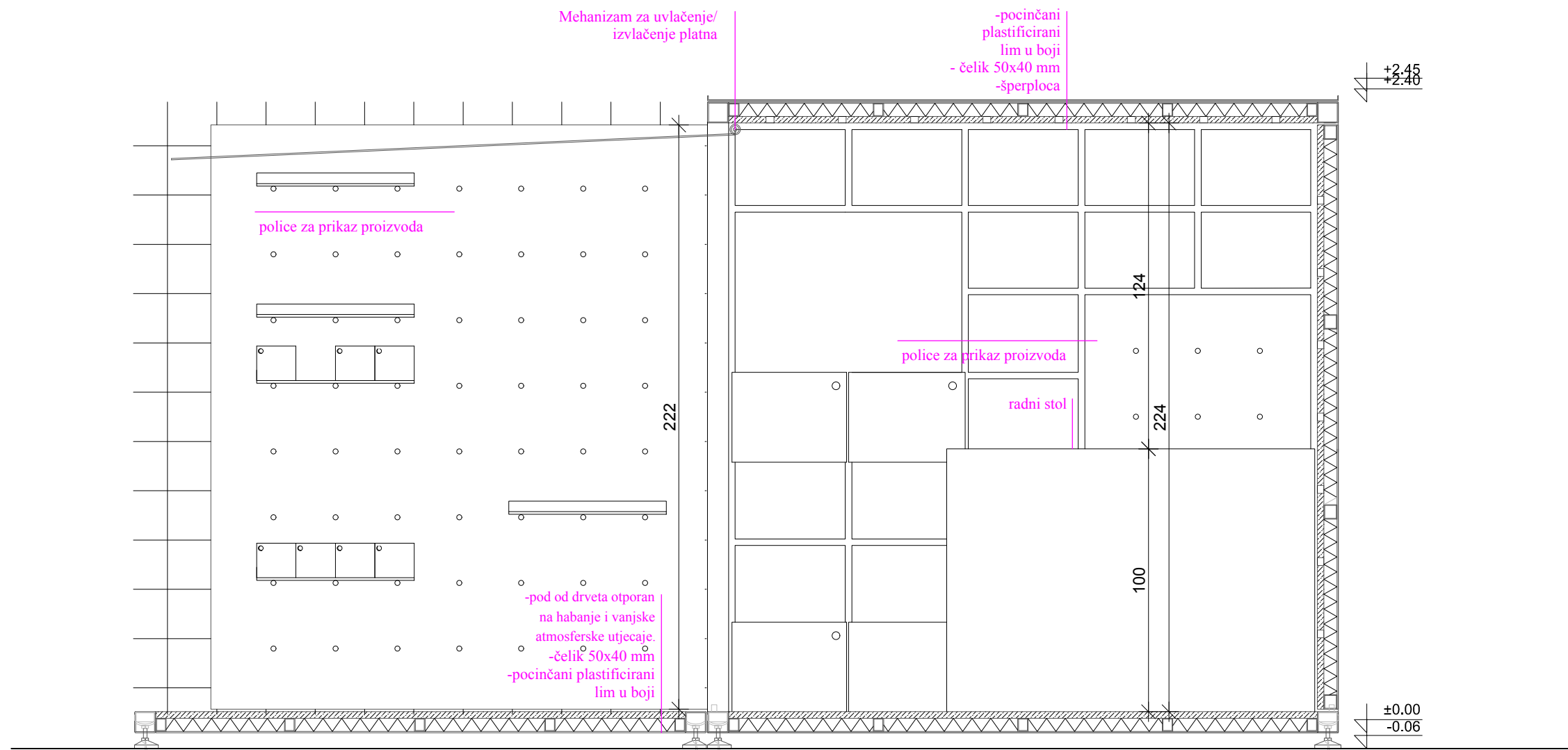

A-A

K. ARH.

K. ARH. d.o.o., za projektiranje i usluge
Baldini 29, 52440 Poreč,
Tel: +386 31 262 940,
e-mail: office@kontra.com
www.kontra.com

Glavni projektant :
Nina Pahović mag.ing.arch.

Projektanti:
Nina Pahović mag.ing.arch.

Suradnici:
Mirjana Lozanovska mag.ing.arch.
Silvija Shaleva mag.ing.arch.
Erik Jurišević abs.arch.

građevina TRG TRADICIJSKIH OBRTA

lokacija k.č. 1539 (dio) k.o. Varaždin

investitor Turistička Zajednica grada Varaždina
Ivana Padovca 3, 42000 Varaždin,

faza GLAVNI PROJEKT

sadržaj PRJESEK A-A

ZOP / TD : 002 - A-002 Mjerilo: 1:20 datum: 02.2019 rev: 00

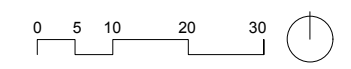

A03

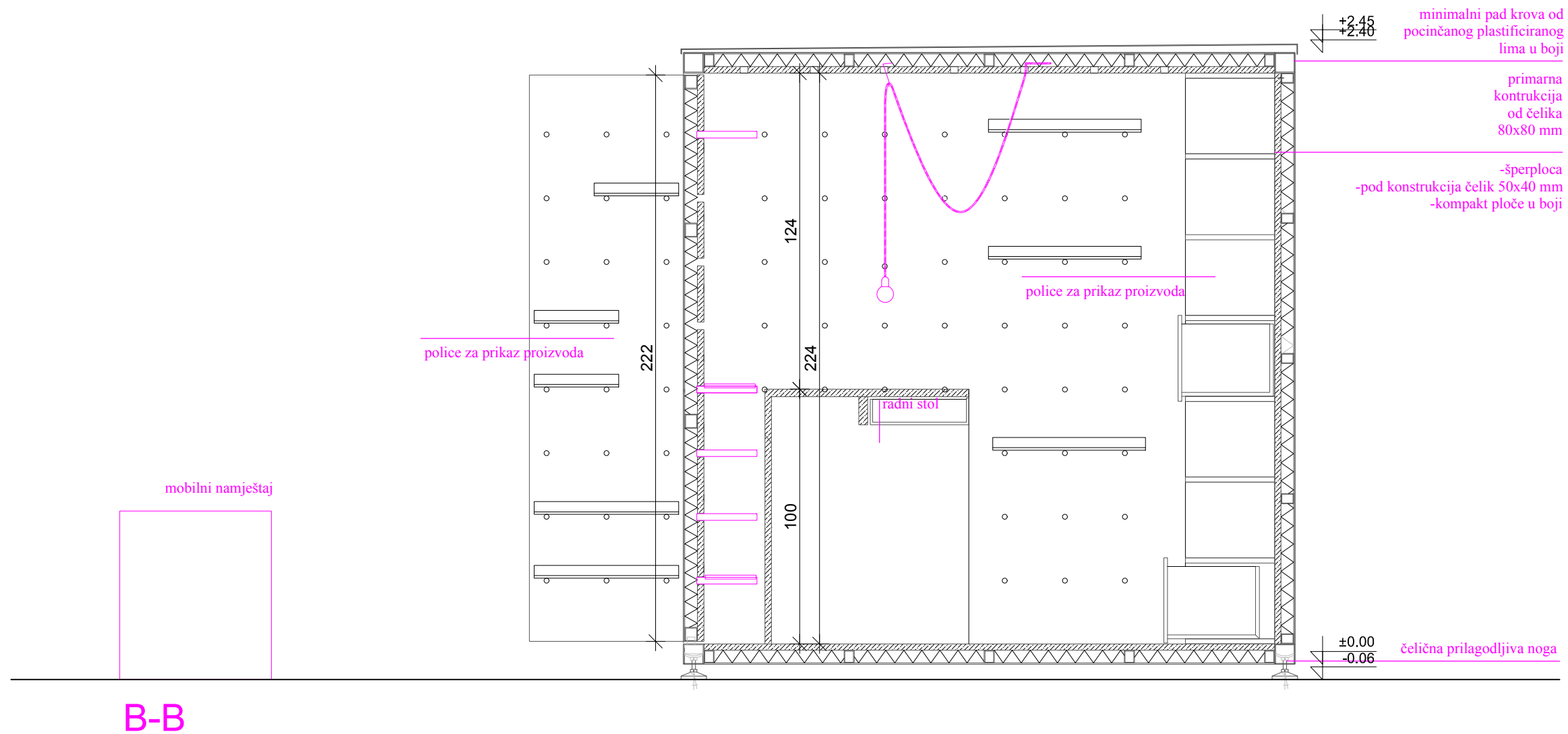

B-B

K. ARH.

K. ARH. d.o.o., za projektiranje i usluge
Baldini 29, 52440 Poreč,
Tel: +386 31 262 940,
e-mail: office@kontra.com
www.kontra.com

Glavni projektant :
Nina Pahović mag.ing.arch.

Projektanti:
Nina Pahović mag.ing.arch.

Suradnici:
Mirjana Lozanovska mag.ing.arch.
Silvija Shaleva mag.ing.arch.
Erik Jurišević abs.arch.

građevina

TRG TRADICIJSKIH OBRTA

lokacija

k.č. 1539 (dio) k.o. Varaždin

investitor

Turistička Zajednica grada Varaždina
Ivana Padovca 3, 42000 Varaždin,

faza

GLAVNI PROJEKT

sadržaj

PRJESEK B-B

ZOP / TD :	Mjerilo.	datum:	rev:
002 - A-002	1:20	02.2019	00

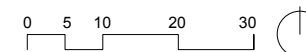

A04

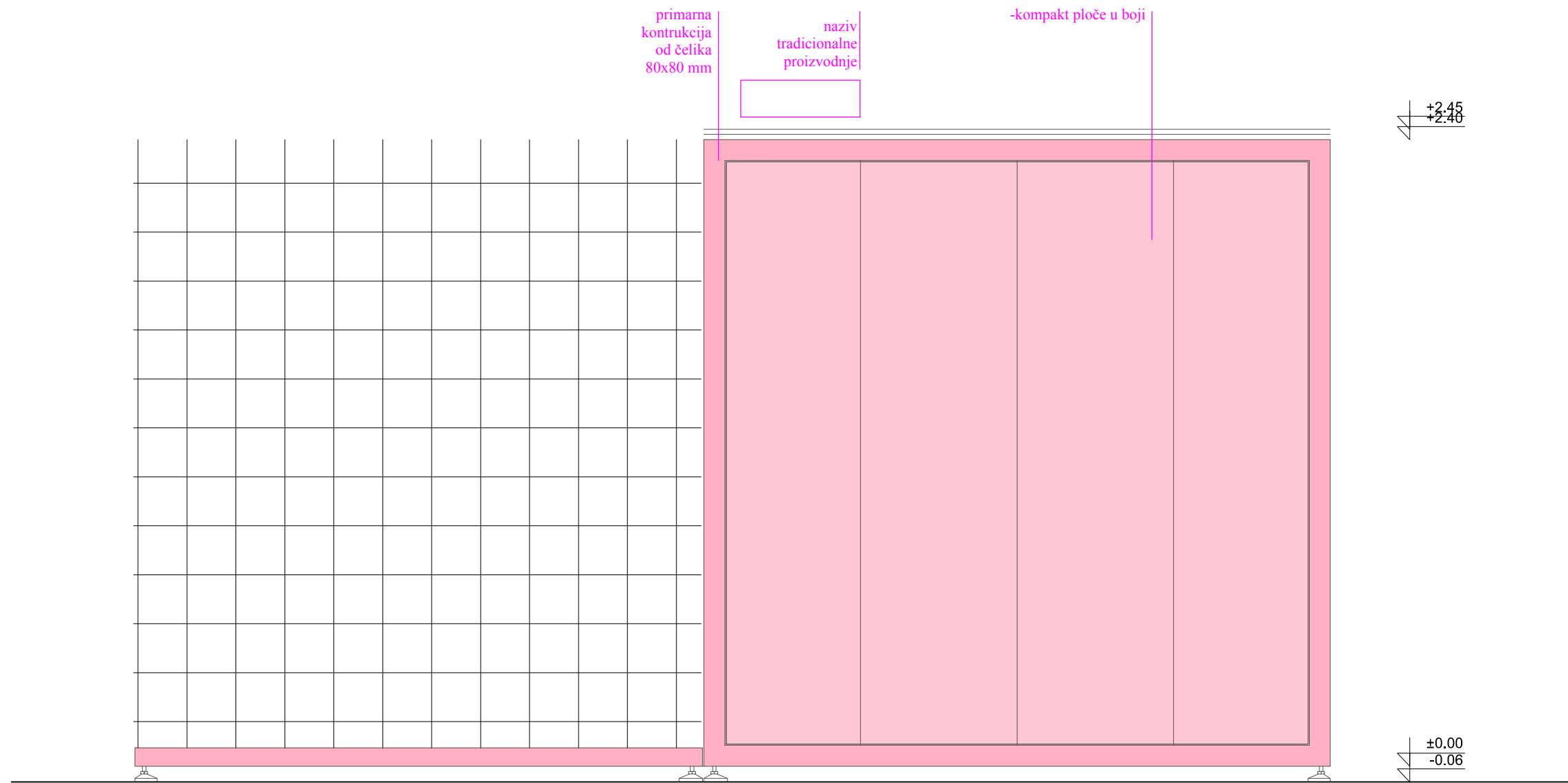

K. ARH.

K. ARH. d.o.o., za projektiranje i usluge
Baldini 29, 52440 Poreč,
Tel: +386 31 262 940,
e-mail: office@kontra.com
www.kontra.com

Glavni projektant :
Nina Pahović mag.ing.arch.

Projektanti:
Nina Pahović mag.ing.arch.

Suradnici:
Mirjana Lozanovska mag.ing.arch.
Silvija Shaleva mag.ing.arch.
Erik Jurišević abs.arch.

građevina

TRG TRADICIJSKIH OBRTA

lokacija

k.č. 1539 (dio) k.o. Varaždin

investitor

Turistička Zajednica grada Varaždina
Ivana Padovca 3, 42000 Varaždin,

faza

GLAVNI PROJEKT

sadržaj

POGLED 1

ZOP / TD :	Mjerilo.	datum:	rev:
002 - A-002	1:20	02.2019	00

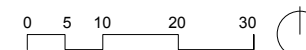

A05

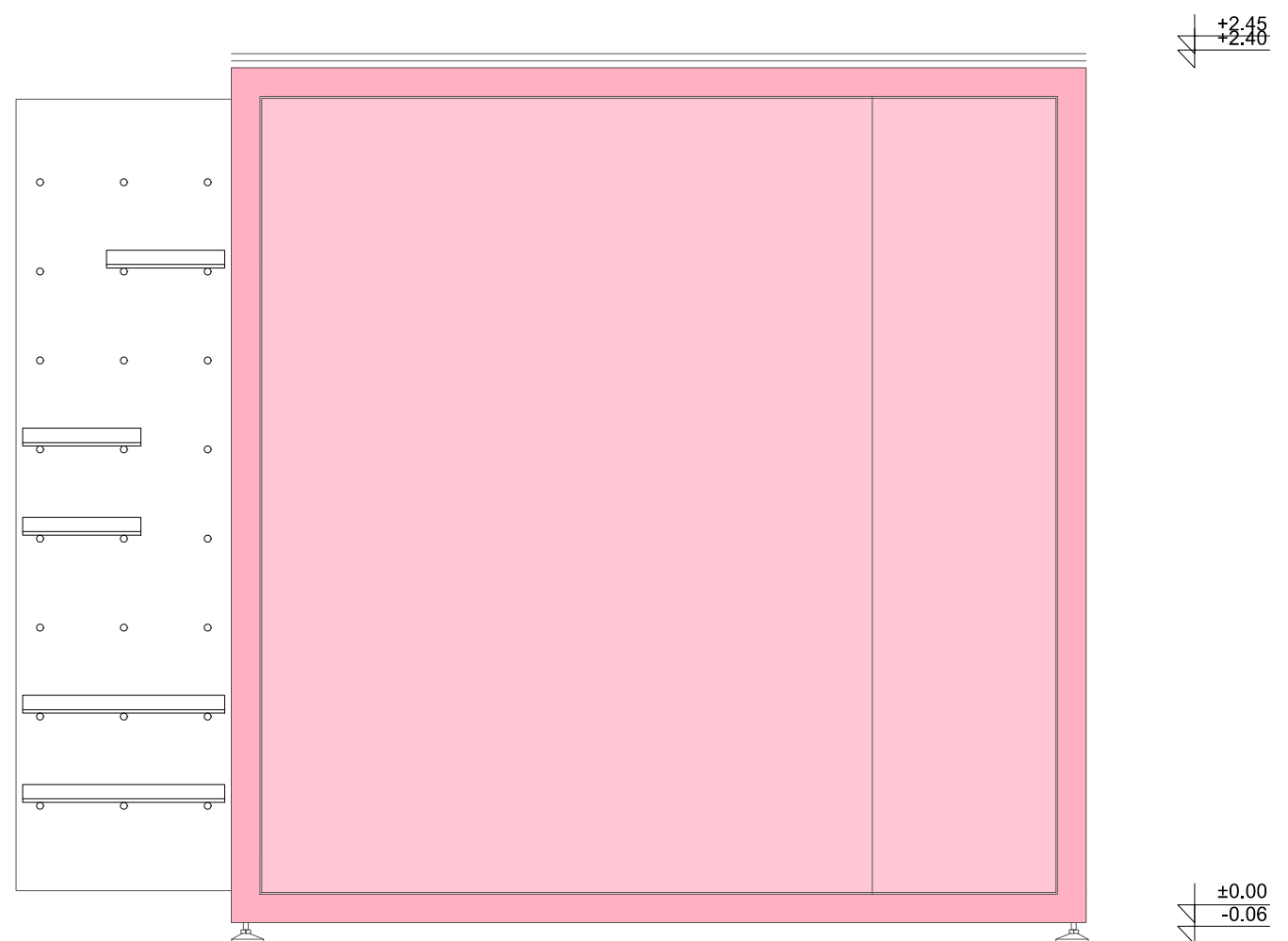

K. ARH.

K. ARH. d.o.o., za projektiranje i usluge
Baldini 29, 52440 Poreč,
Tel: +386 31 262 940,
e-mail: office@kontra.com
www.kontra.com

Glavni projektant :
Nina Pahović mag.ing.arch.

Projektanti:
Nina Pahović mag.ing.arch.

Suradnici:
Mirjana Lozanovska mag.ing.arch.
Silvija Shaleva mag.ing.arch.
Erik Jurišević abs.arch.

građevina TRG TRADICIJSKIH OBRTA

lokacija k.č. 1539 (dio) k.o. Varaždin

investitor Turistička Zajednica grada Varaždina
Ivana Padovca 3, 42000 Varaždin,

faza GLAVNI PROJEKT

sadržaj POGLED 2

ZOP / TD :	Mjerilo.	datum:	rev:
002 - A-002	1:20	02.2019	00

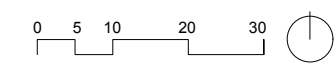

A06

ELEMENTI EKSTERIER

1. KOMPAKT PLOČE U BOJI

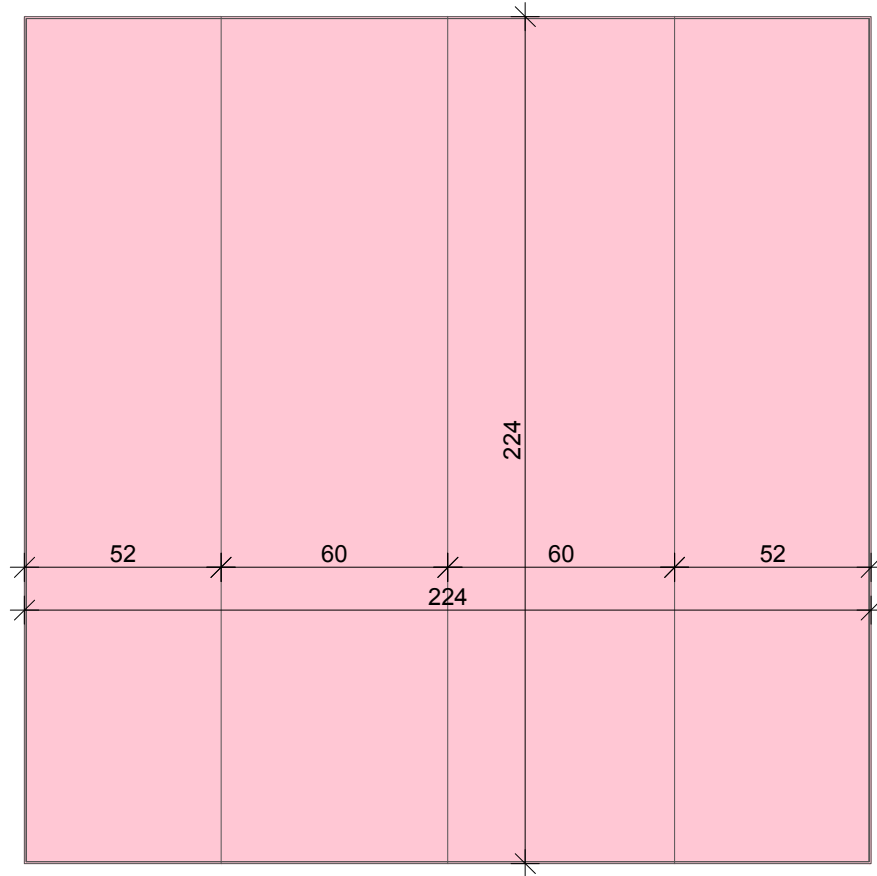

1.1 KOMPAKT PLOČE PREDNJA STRANA

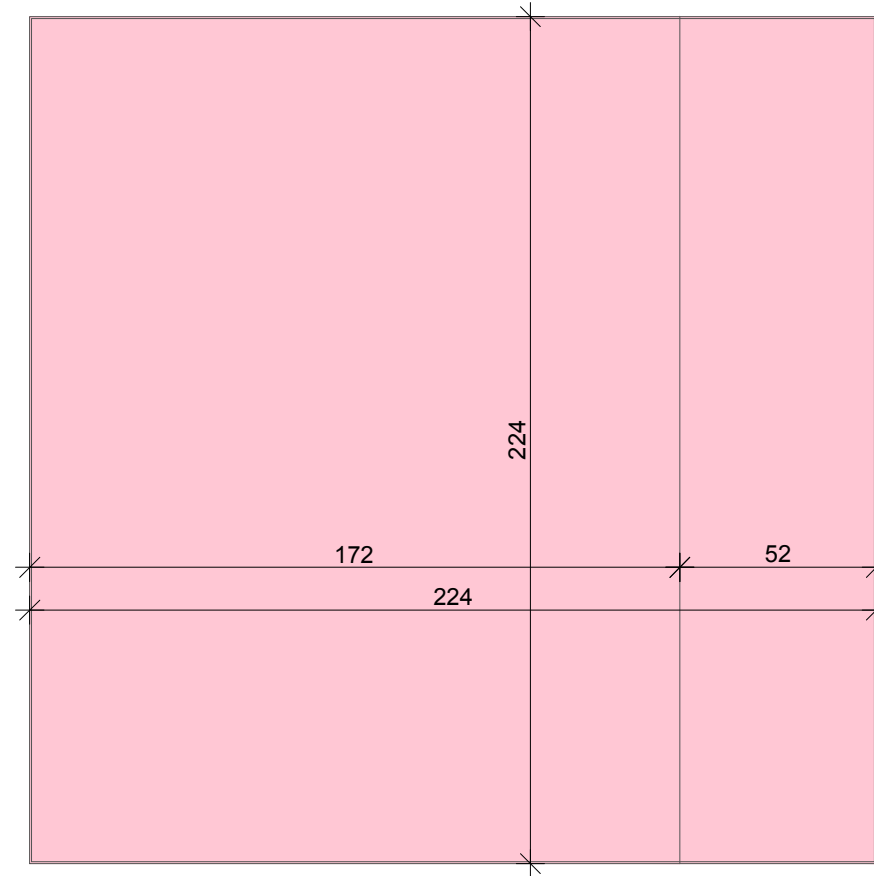

1.2 KOMPAKT PLOČE BOČNA STRANA SA LIJEVE STRANE

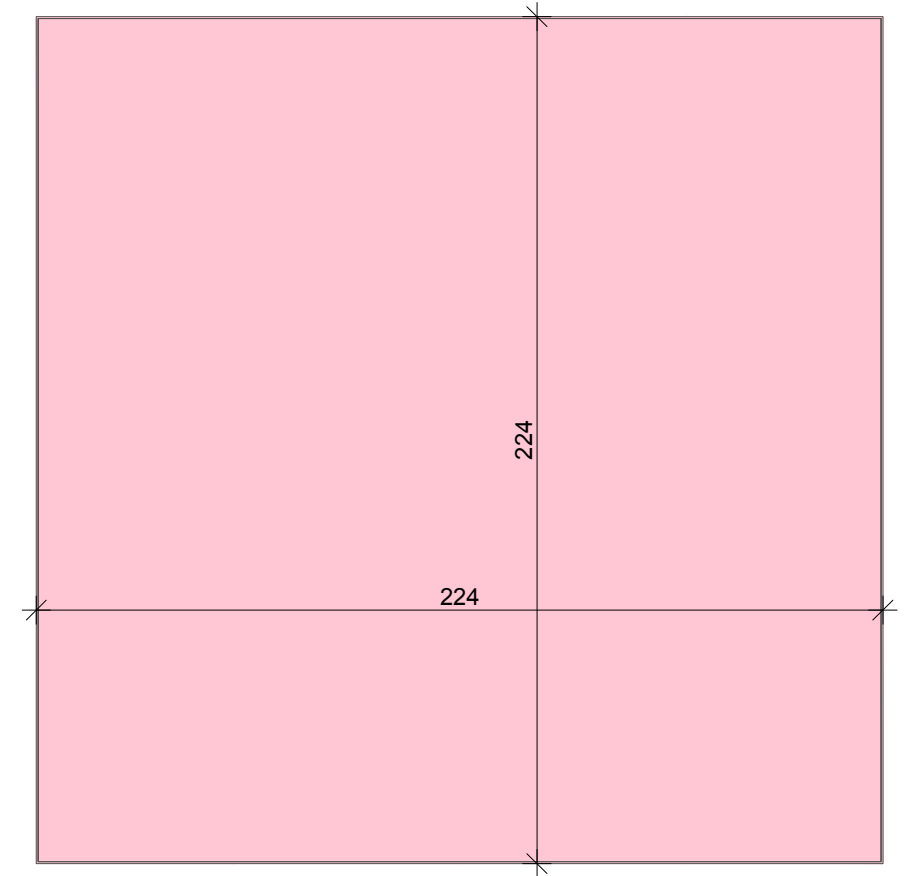

1.3 KOMPAKT PLOČE STRAŽNJA STRANA

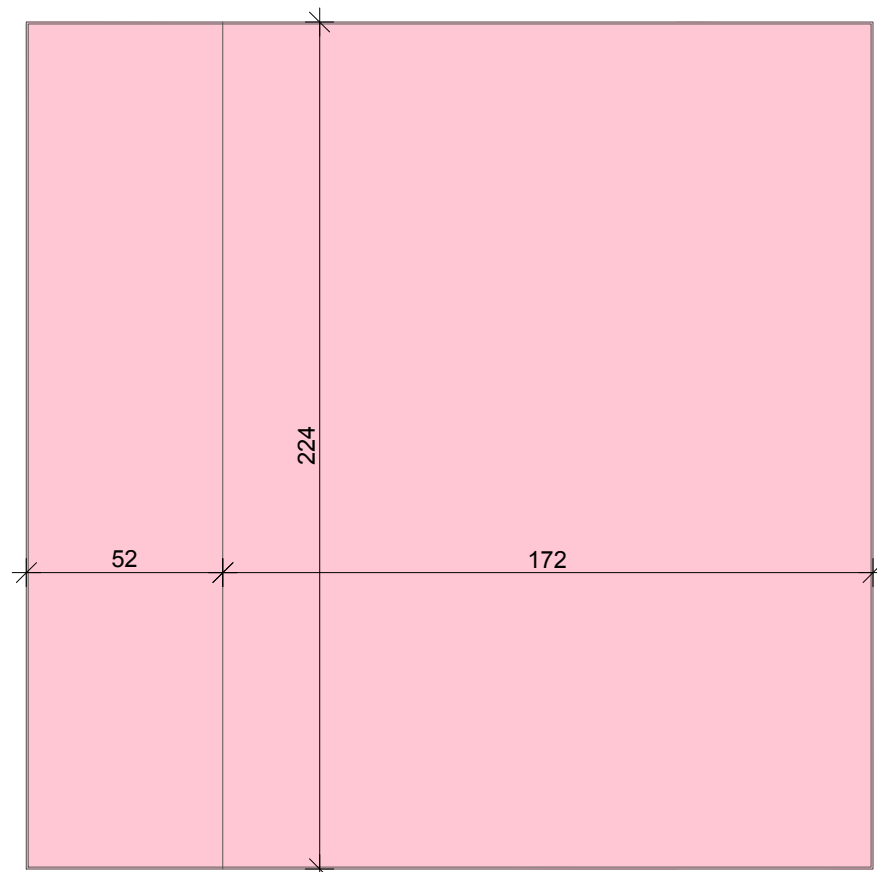

1.4 KOMPAKT PLOČE BOČNA STRANA SA DESNE STRANE

K. ARH.

K. ARH. d.o.o., za projektiranje i usluge
Baldini 29, 52440 Poreč,
Tel: +386 31 262 940,
e-mail: office@kontra.com
www.kontra.com

Glavni projektant :
Nina Pahović mag.ing.arch.

Projektanti:
Nina Pahović mag.ing.arch.

Suradnici:
Mirjana Lozanovska mag.ing.arch.
Silvija Shaleva mag.ing.arch.
Erik Jurišević abs.arch.

građevina TRG TRADICIJSKIH OBRTA

lokacija k.č. 1539 (dio) k.o. Varaždin

investitor Turistička Zajednica grada Varaždina
Ivana Padovca 3, 42000 Varaždin,

faza GLAVNI PROJEKT

sadržaj SCHEME EKSTERIJER

ZOP / TD : 002 - A-002 Mjerilo: 1:20 datum: 02.2019 rev: 00

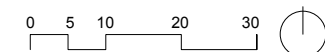

A07

2.KONSTRUKCIJA

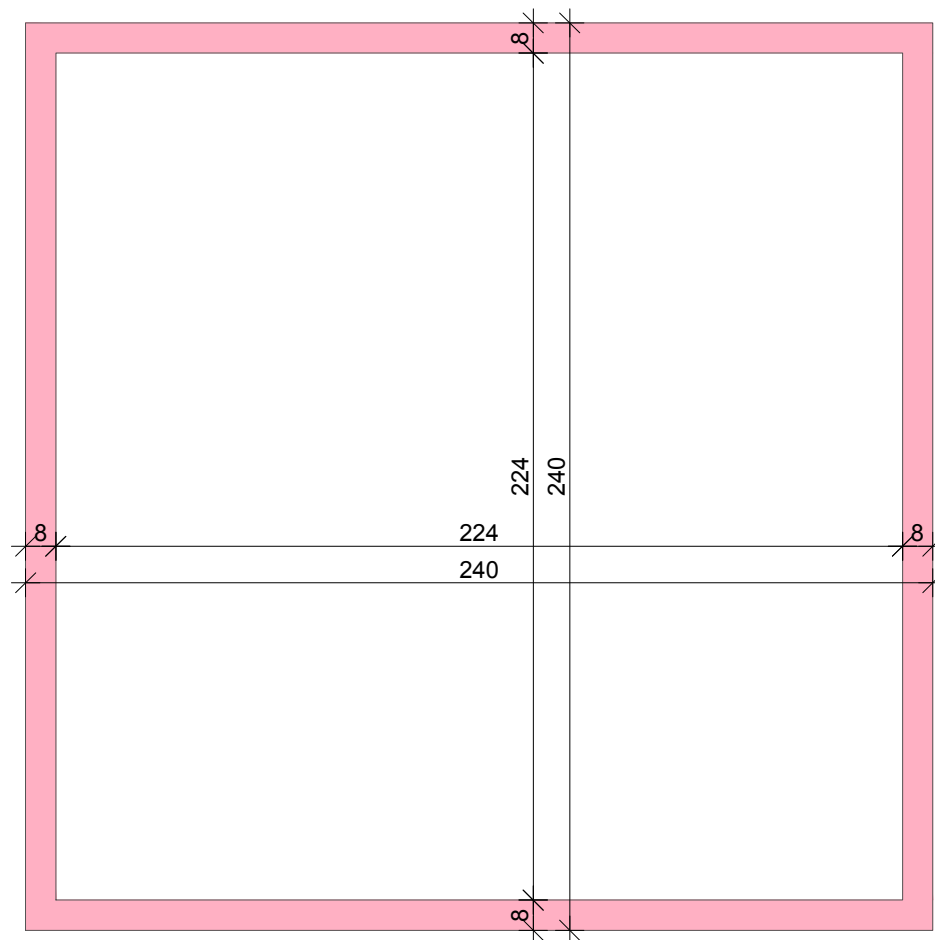

2.1 KONSTRUKTIVNI ELEMENT A
primarna konstrukcija iz čelika 80x80 mm

2.4 KONSTRUKTIVNI ELEMENT B
konstrukcija čelik 50x40 mm

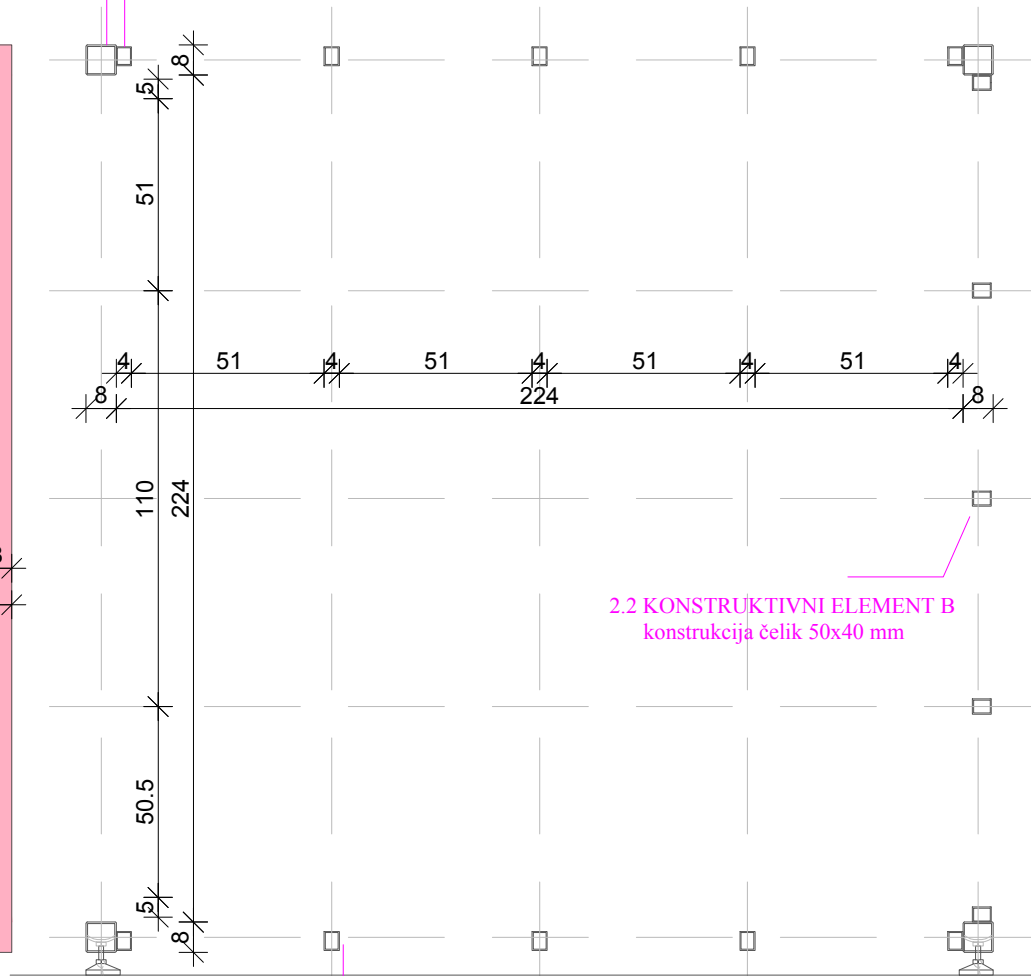

2.2 KONSTRUKTIVNI ELEMENT B
konstrukcija čelik 50x40 mm

pogled

2.3 KONSTRUKTIVNI ELEMENT B
konstrukcija čelik 50x40 mm

tlocrt

3. MINIMALNI PAD KROVA POCINČANOG PLASTIFICIRANOG LIMA U BOJI

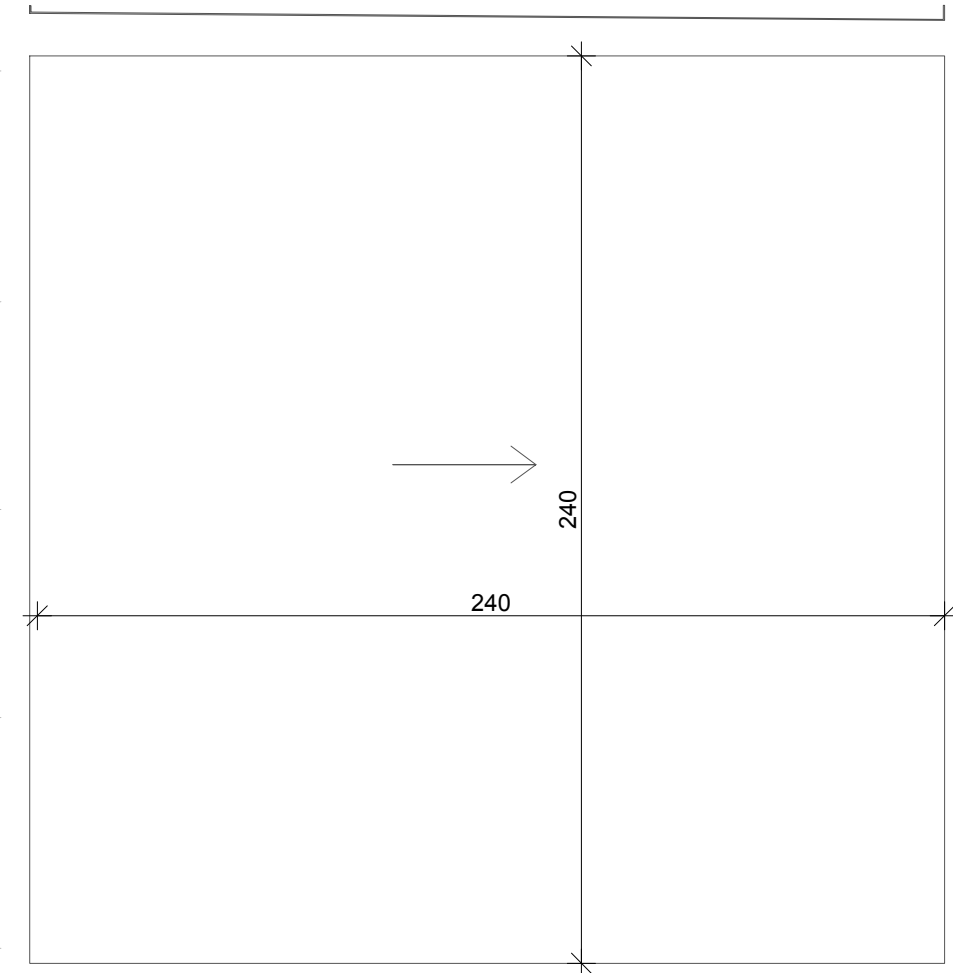

K. ARH.

K. ARH. d.o.o., za projektiranje i usluge
Baldini 29, 52440 Poreč,
Tel: +386 31 262 940,
e-mail: office@kontra.com
www.kontra.com

Glavni projektant :
Nina Pahović mag.ing.arch.

Projektanti:
Nina Pahović mag.ing.arch.

Suradnici:
Mirjana Lozanovska mag.ing.arch.
Silvija Shaleva mag.ing.arch.
Erik Jurišević abs.arch.

građevina TRG TRADICIJSKIH OBRTA

lokacija k.č. 1539 (dio) k.o. Varaždin

investitor Turistička Zajednica grada Varaždina
Ivana Padovca 3, 42000 Varaždin,

faza GLAVNI PROJEKT

sadržaj SCHEME EKSTERIJER

ZOP / TD : 002 - A-002 Mjerilo: 1:20 datum: 02.2019 rev: 00

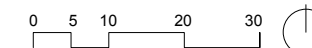

A08

4. VANJSKI PODEST - SASTAVNI DIO MODULA

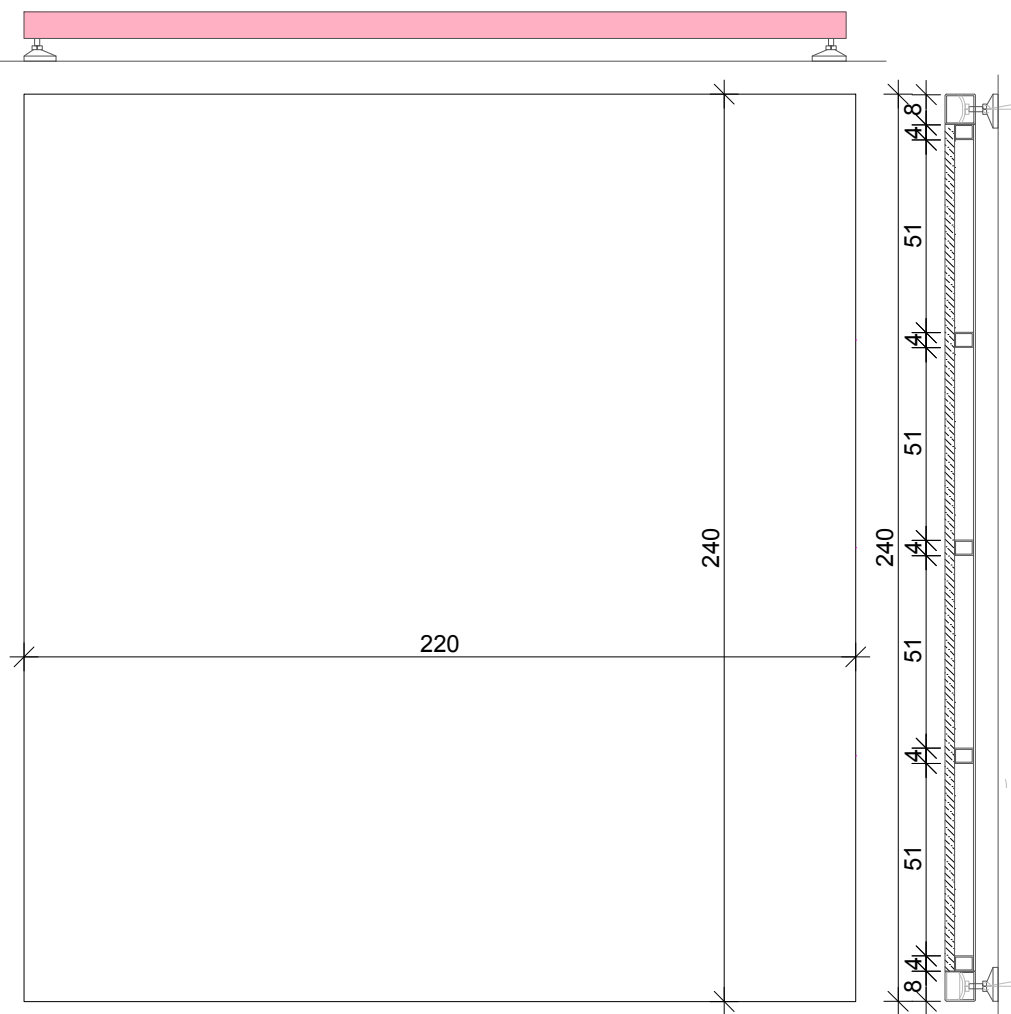
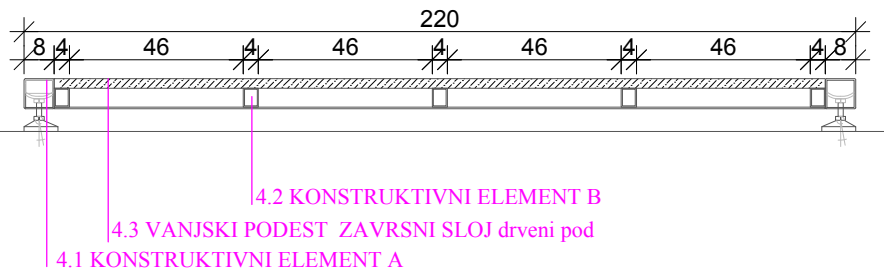

5. ČELICNA PRILAGODLJIVA NOGA

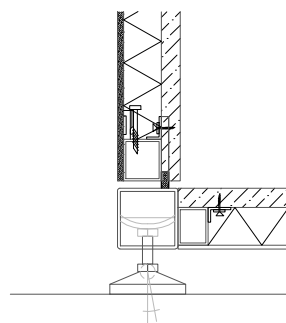

7. MEHANIZAM ZA UVLAČENJE / IZVLAČENJE PLATNA

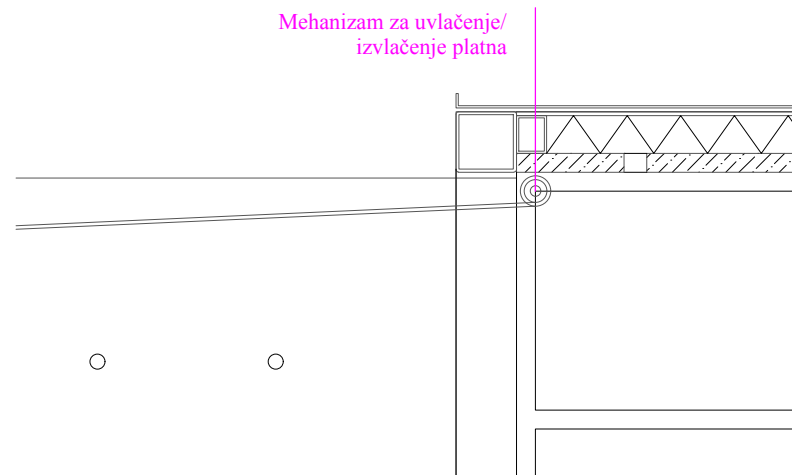

9. NAZIVI OBRTA NASLOV ZA KUCICA

KLOBUCAR
47

8.5

* TEKST SE IZVODI OVISNO O OBRTU KOJI SE UNUTRA PREZENTIRA

K. ARH.

K. ARH. d.o.o., za projektiranje i usluge
Baldini 29, 52440 Poreč,
Tel: +386 31 262 940,
e-mail: office@kontra.com
www.kontra.com

građevina

TRG TRADICIJSKIH OBRTA

lokacija

k.č. 1539 (dio) k.o. Varaždin

Glavni projektant :
Nina Pahović mag.ing.arch.

investitor

Turistička Zajednica grada Varaždina
Ivana Padovca 3, 42000 Varaždin,

Projektanti:
Nina Pahović mag.ing.arch.

faza

GLAVNI PROJEKT

Suradnici:
Mirjana Lozanovska mag.ing.arch.
Silvija Shaleva mag.ing.arch.
Erik Jurišević abs.arch.

sadržaj

SHEME EKSTERIJER

ZOP / TD : 002 - A-002 Mjerilo: 1:20 datum: 02.2019 rev: 00

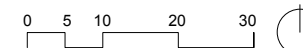

A09

1. LIJEVA I DESNA VRATA ZA PRIKAZ PROIZVODA (drvena ploča) X 2

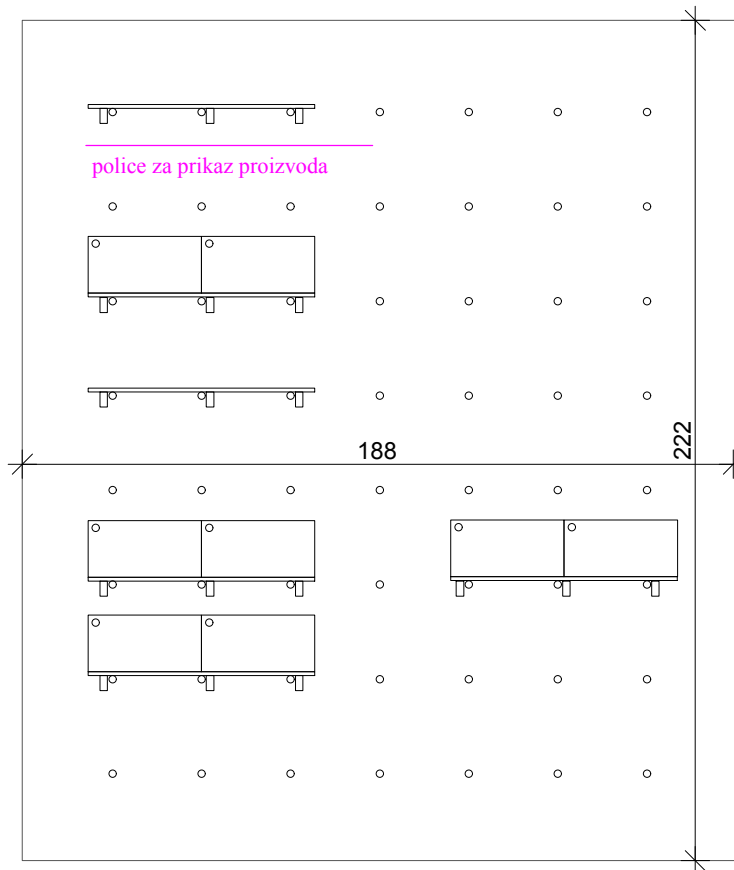
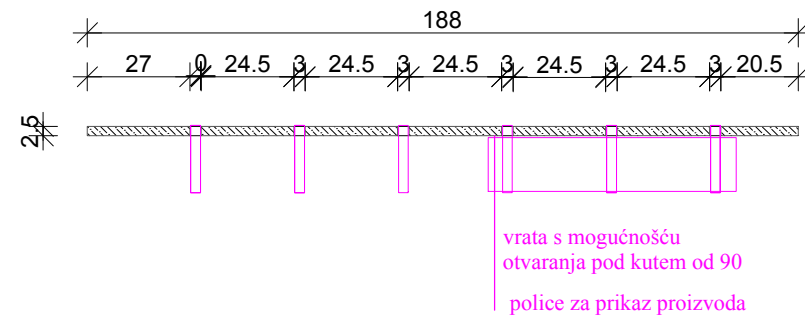

1.2 POLICE ZA PRIKAZ PROIZVODA

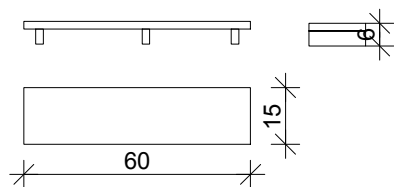

1.3 KUTIJE ZA PRIKAZ PROIZVODA

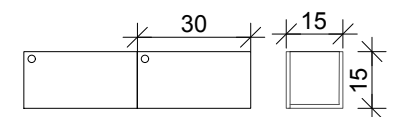

1.4, 2.4, 3.5 DRVENI ŠTAPOVI



2. LIJEVA I DESNA PREDNJA VRATA ZA PRIKAZ PROIZVODA X 4

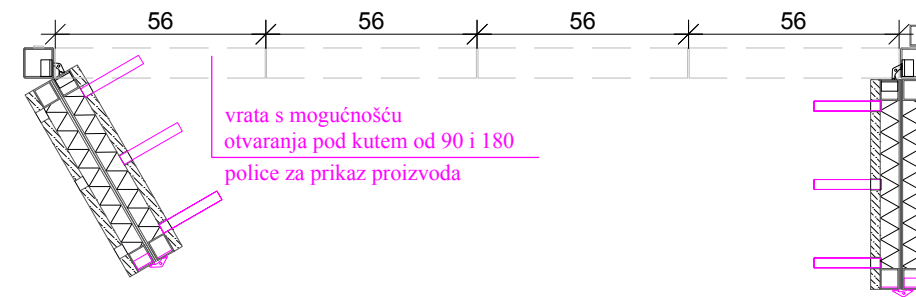

2.2 POLICE TIP 1 X 3

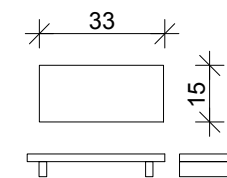

2.3 POLICE TIP 2 X 3

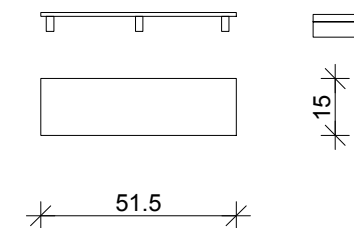

2.1 PLOČA ZA PRIKAZ PROIZVODA TIP 3

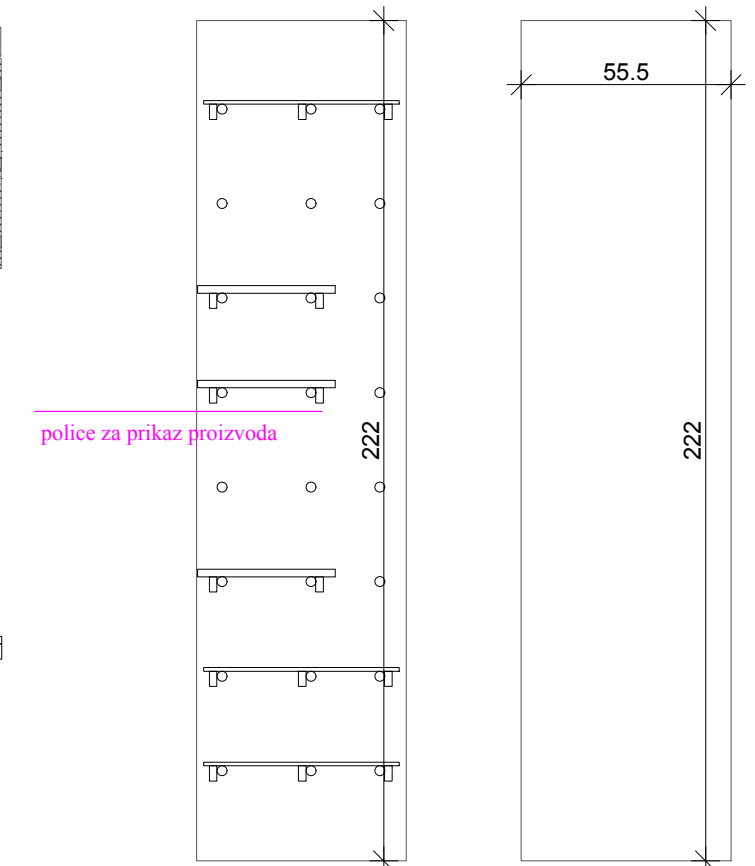

K. ARH.

K. ARH. d.o.o., za projektiranje i usluge
Baldini 29, 52440 Poreč,
Tel: +386 31 262 940,
e-mail: office@kontra.com
www.kontra.com

građevina

TRG TRADICIJSKIH OBRTA

lokacija

k.č. 1539 (dio) k.o. Varaždin

Glavni projektant :
Nina Pahović mag.ing.arch.

investitor

Turistička Zajednica grada Varaždina
Ivana Padovca 3, 42000 Varaždin,

Projektanti:
Nina Pahović mag.ing.arch.

faza

GLAVNI PROJEKT

sadržaj

HEME INTERIJER

Suradnici:
Mirjana Lozanovska mag.ing.arch.
Silvija Shaleva mag.ing.arch.
Erik Jurišević abs.arch.

ZOP / TD : 002 - A-002
Mjerilo: 1:20
datum: 02.2019
rev: 00

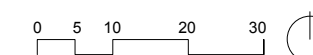

A10

3. POLICA-IZLOZBENI ZID

3.1 PLOČA ZA PRIKAZ PROIZVODA TIP 2

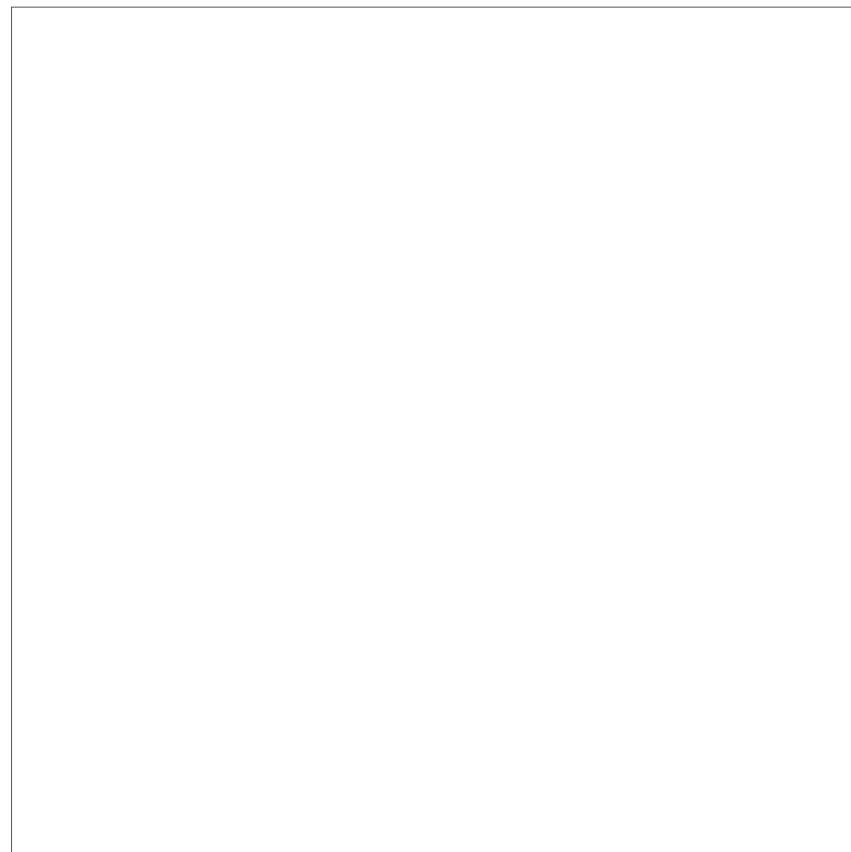

224

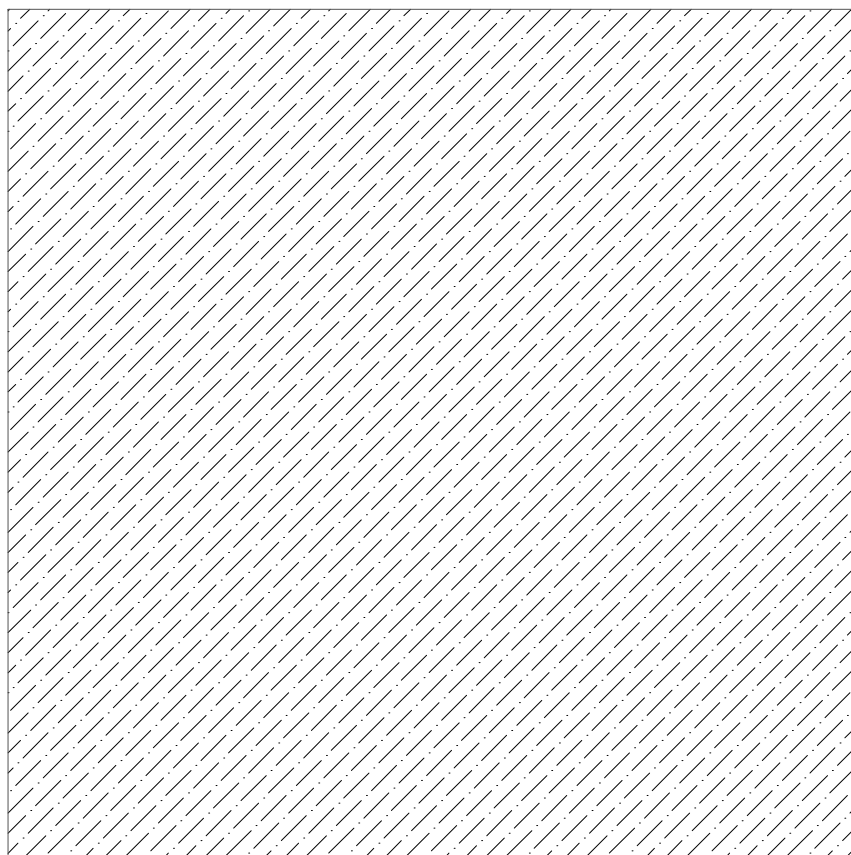

3.2 POLICE

- pocinčani
plastificirani
lim u boji
- čelik 50x40 mm
- šperploča

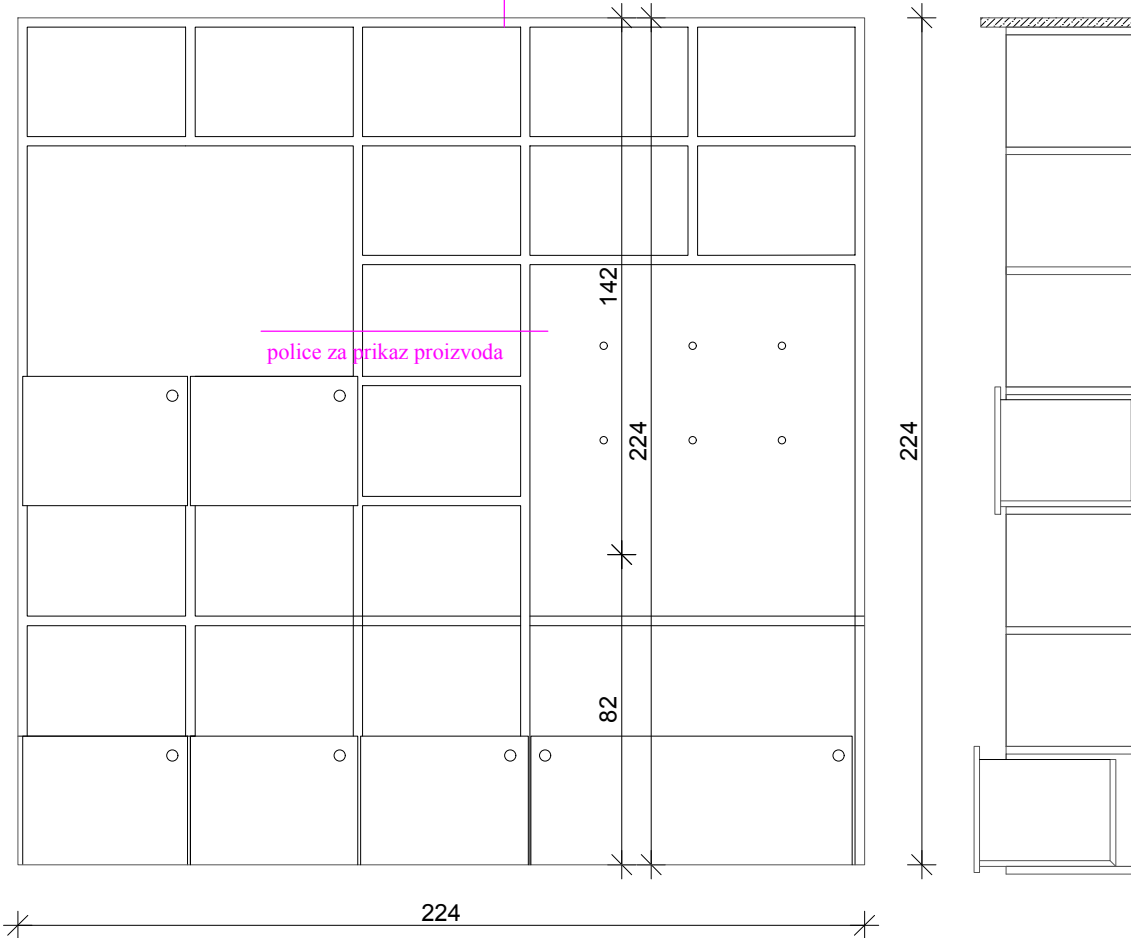

224

4. DRVENI POD

2,5
224
2,5

3.3 KUTIJE ZA PRIKAZ PROIZVODA TIP 1 X5

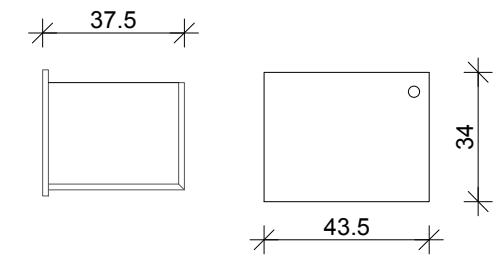

3.4 KUTIJE ZA PRIKAZ PROIZVODA TIP 2 X1

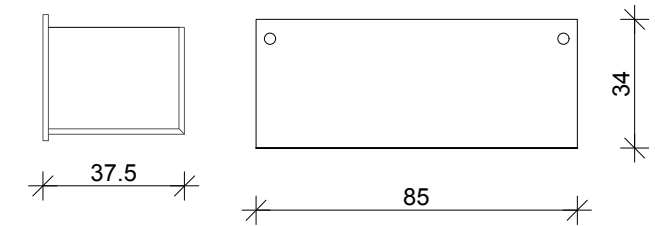

K. ARH.

K. ARH. d.o.o., za projektiranje i usluge
Baldini 29, 52440 Poreč,
Tel: +386 31 262 940,
e-mail: office@kontra.com
www.kontra.com

Glavni projektant:
Nina Pahović mag.ing.arch.

Projektanti:
Nina Pahović mag.ing.arch.

Suradnici:
Mirjana Lozanovska mag.ing.arch.
Silvija Shaleva mag.ing.arch.
Erik Jurišević abs.arch.

građevina

TRG TRADICIJSKIH OBRTA

lokacija

k.č. 1539 (dio) k.o. Varaždin

investitor

Turistička Zajednica grada Varaždina
Ivana Padovca 3, 42000 Varaždin,

faza

GLAVNI PROJEKT

sadržaj

SHEME INTERIJER

ZOP / TD : Mjerilo. datum: rev:
002 - A-002 1:20 02.2019 00

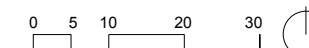

A11

6. RADNI STOL

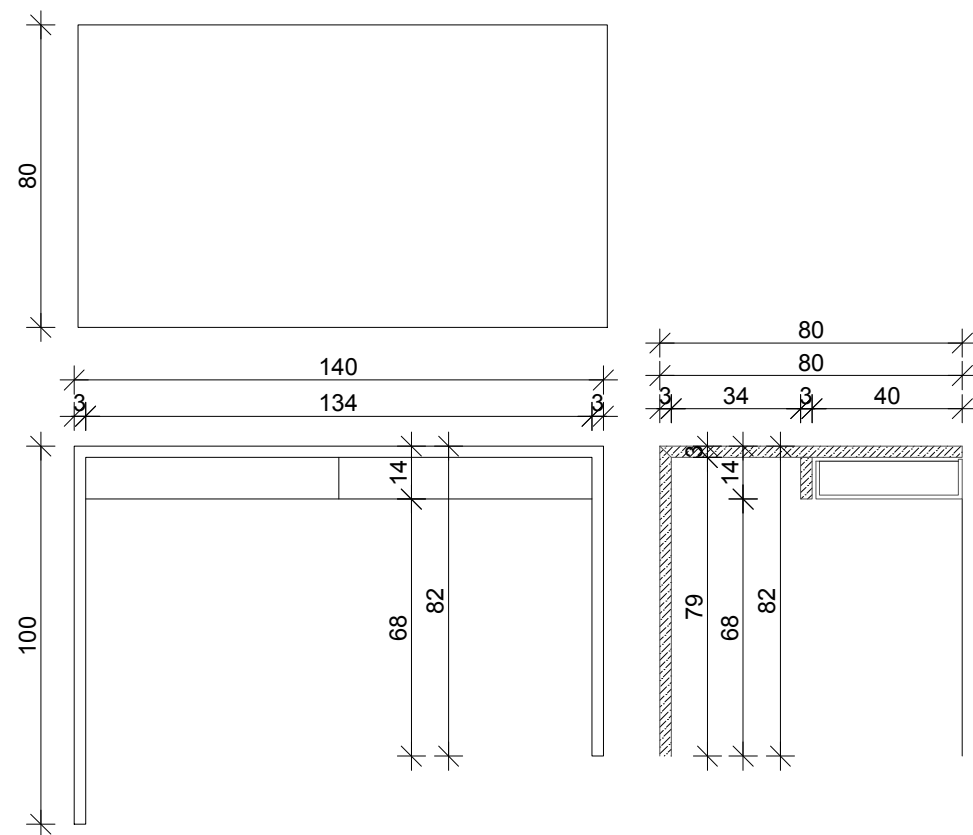

7. STOLICA

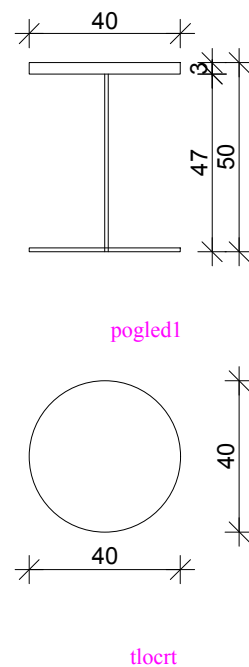

8. MOBILNA MODULARNA STOLICA

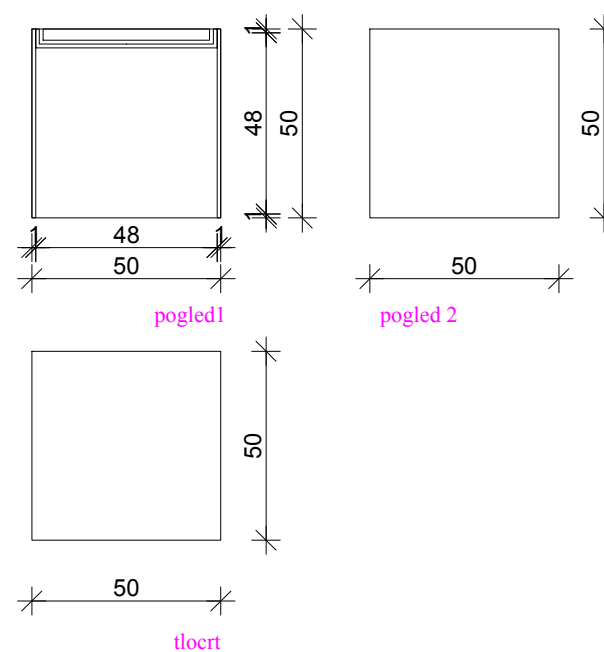

5. PLAFON SA DRVOM

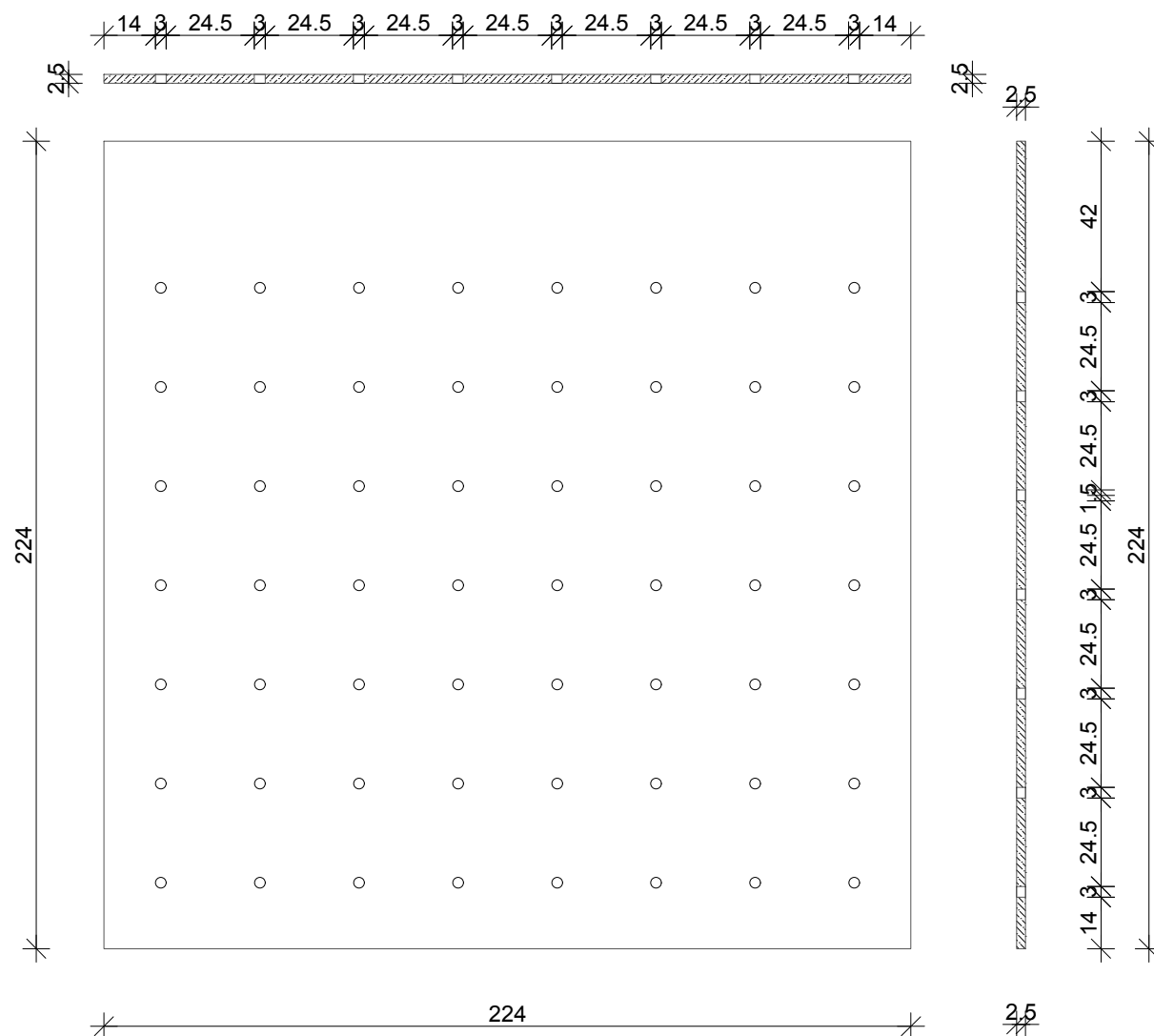

K. ARH.
K. ARH. d.o.o., za projektiranje i usluge
Baldini 29, 52440 Poreč,
Tel: +386 31 262 940,
e-mail: office@kontra.com
www.kontra.com

građevina	TRG TRADICIJSKIH OBRTA
lokacija	k.č. 1539 (dio) k.o. Varaždin
investitor	Turistička Zajednica grada Varaždina Ivana Padovca 3, 42000 Varaždin,
faza	GLAVNI PROJEKT
sadržaj	HEME INTERIJER
Suradnici:	ZOP / TD : Mjerilo. datum: rev:
Mirjana Lozanovska mag.ing.arch.	002 - A-002 1:20 02.2019 00
Silvija Shaleva mag.ing.arch.	
Erik Jurišević abs.arch.	

A12

9. RASVIJETA U INTERIJERU

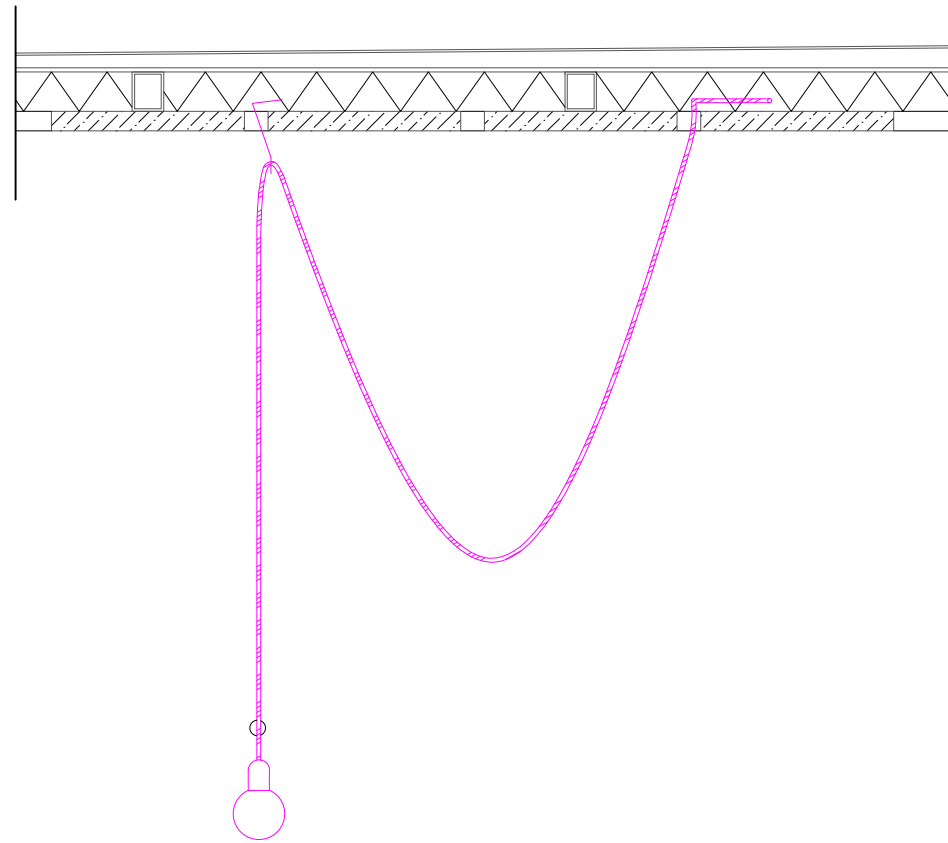

K. ARH.

K. ARH. d.o.o., za projektiranje i usluge
Baldini 29, 52440 Poreč,
Tel: +386 31 262 940,
e-mail: office@kontra.com
www.kontra.com

Glavni projektant :
Nina Pahović mag.ing.arch.

Projektanti:
Nina Pahović mag.ing.arch.

Suradnici:
Mirjana Lozanovska mag.ing.arch.
Silvija Shaleva mag.ing.arch.
Erik Jurišević abs.arch.

građevina

TRG TRADICIJSKIH OBRTA

lokacija

k.č. 1539 (dio) k.o. Varaždin

investitor

Turistička Zajednica grada Varaždina
Ivana Padovca 3, 42000 Varaždin,

faza

GLAVNI PROJEKT

sadržaj

HEME INTERIJER

ZOP / TD : Mjerilo. datum: rev:
002 - A-002 1:20 02.2019 00

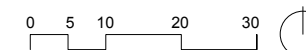

A13

ELEMENTI EKSTERIJER TRG

+

+

3. CENTRALNI IZLOŽBENI ELEMENT

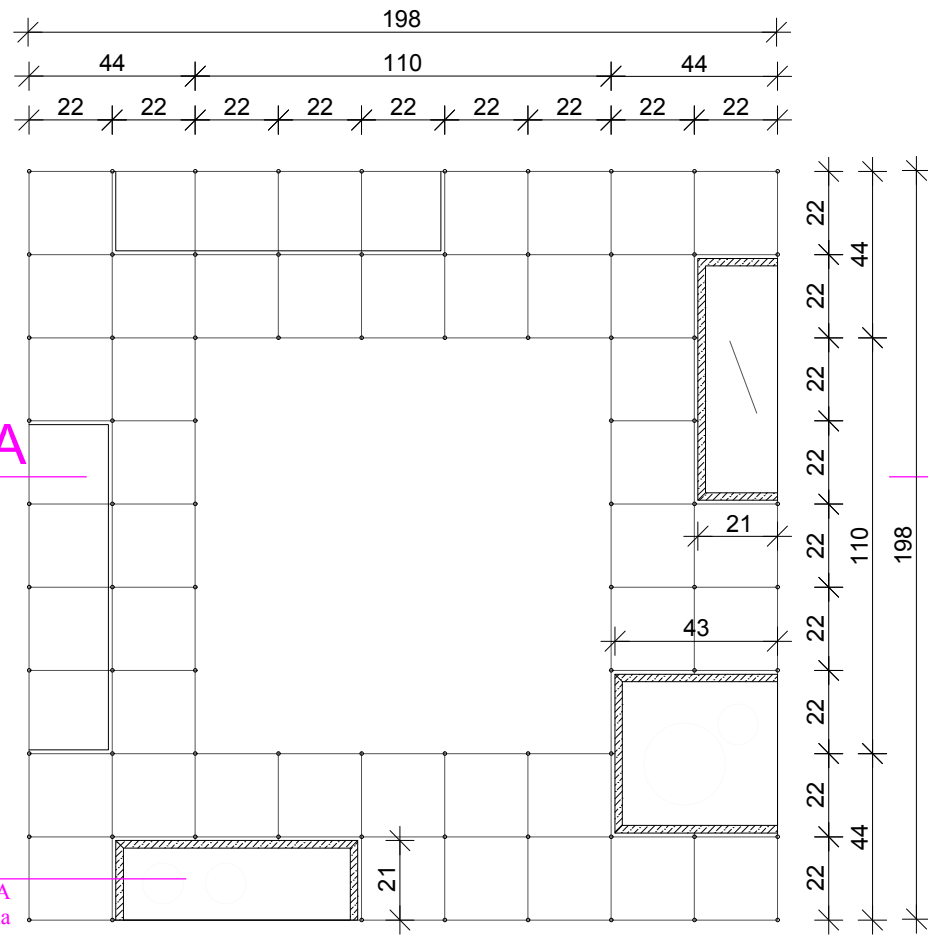

TLOCRT

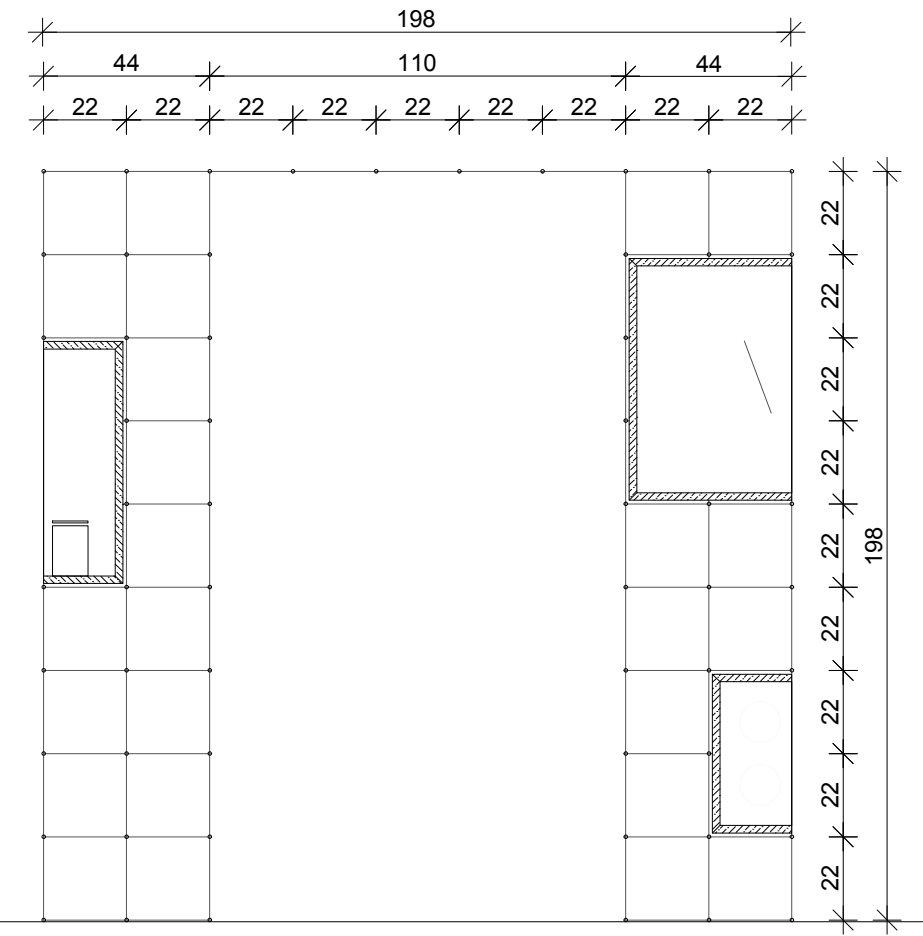

PRESJEK AA

K. ARH.

K. ARH. d.o.o., za projektiranje i usluge
Baldini 29, 52440 Poreč,
Tel: +386 31 262 940,
e-mail: office@kontra.com
www.kontra.com

Glavni projektant :
Nina Pahović mag.ing.arch.

Projektanti:
Nina Pahović mag.ing.arch.

Suradnici:
Mirjana Lozanovska mag.ing.arch.
Silvija Shaleva mag.ing.arch.
Erik Jurišević abs.arch.

građevina

TRG TRADICIJSKIH OBRTA

lokacija

k.č. 1539 (dio) k.o. Varaždin

investitor

Turistička Zajednica grada Varaždina
Ivana Padovca 3, 42000 Varaždin,

faza

GLAVNI PROJEKT

sadržaj

HEMA OSREDNJI PROSTOR IZLOŽBE

ZOP / TD : 002 - A-002 Mjerilo: 1:20 datum: 02.2019 rev: 00

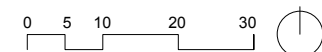

A14

3.2 ČELIČNE ARMAURNE ŠIPKE
napravljene od armaturnih šipki Ø 0,5cm

3. DRVENA IZLOŽBENA KUTIJA
-prednja strana od pleksi stakla

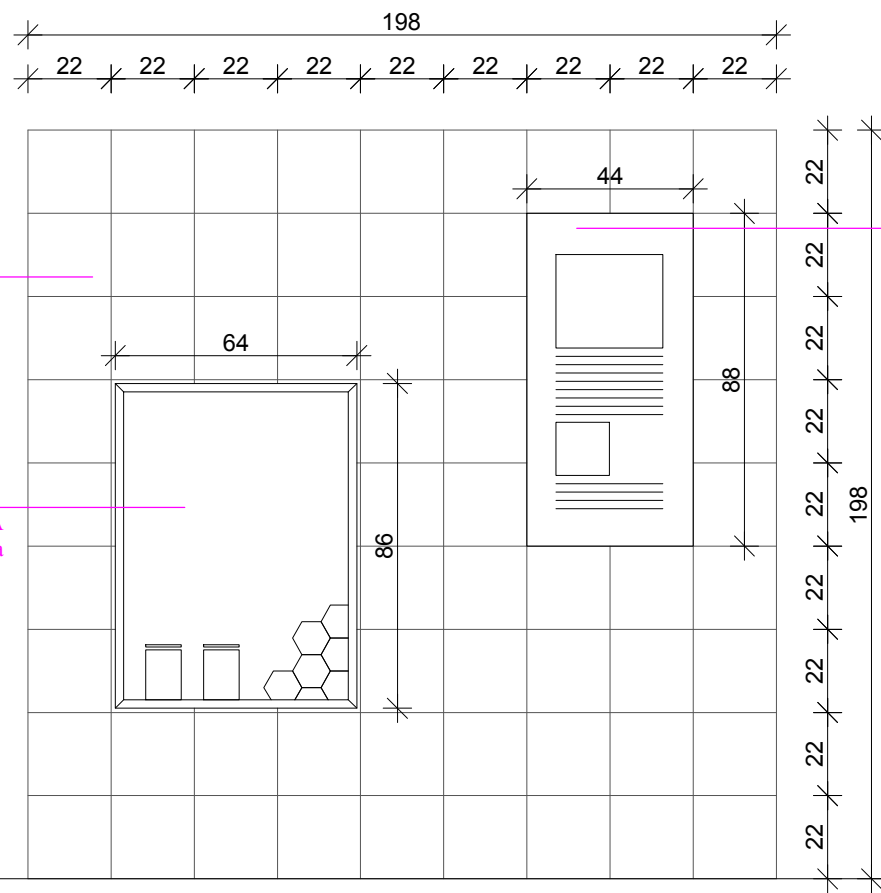

POGLED 1

info ploča od plastificiranog lima

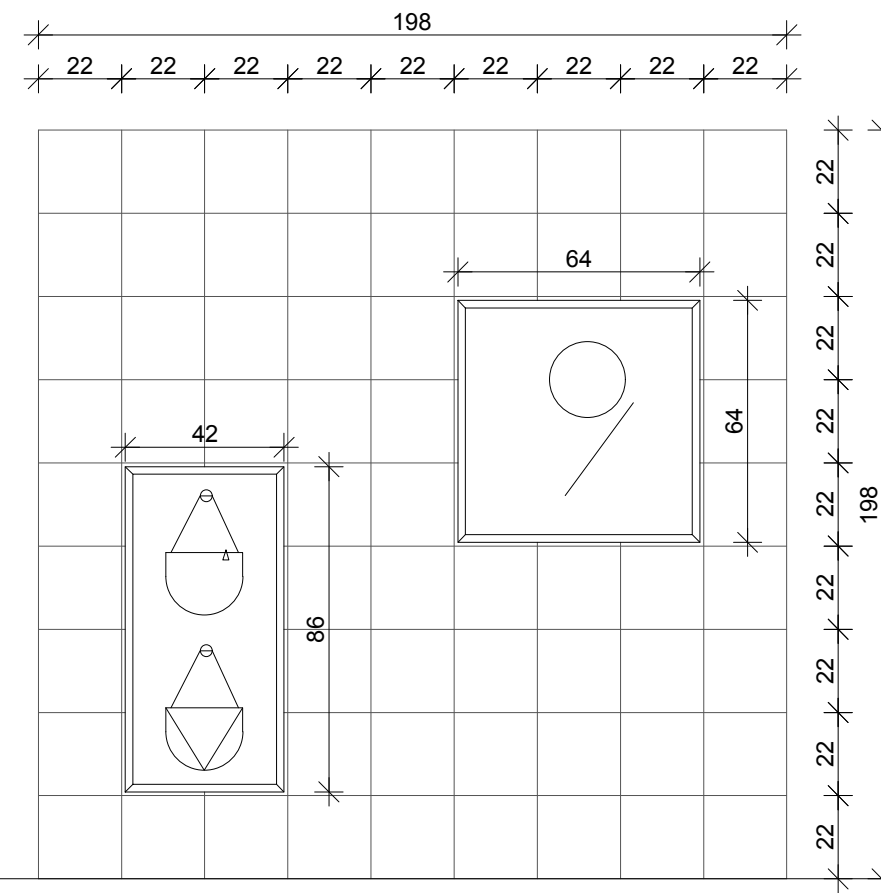

K. ARH.

K. ARH. d.o.o., za projektiranje i usluge
Baldini 29, 52440 Poreč,
Tel: +386 31 262 940,
e-mail: office@kontra.com
www.kontra.com

građevina

TRG TRADICIJSKIH OBRTA

lokacija

k.č. 1539 (dio) k.o. Varaždin

Glavni projektant :
Nina Pahović mag.ing.arch.

investitor

Turistička Zajednica grada Varaždina
Ivana Padovca 3, 42000 Varaždin,

Projektanti:
Nina Pahović mag.ing.arch.

faza

GLAVNI PROJEKT

Suradnici:
Mirjana Lozanovska mag.ing.arch.
Silvija Shaleva mag.ing.arch.
Erik Jurišević abs.arch.

sadržaj

HEMA OSREDNJI PROSTOR IZLOŽBE

ZOP / TD : 002 - A-002 Mjerilo: 1:20 datum: 02.2019 rev: 00

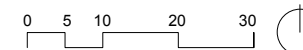

A15

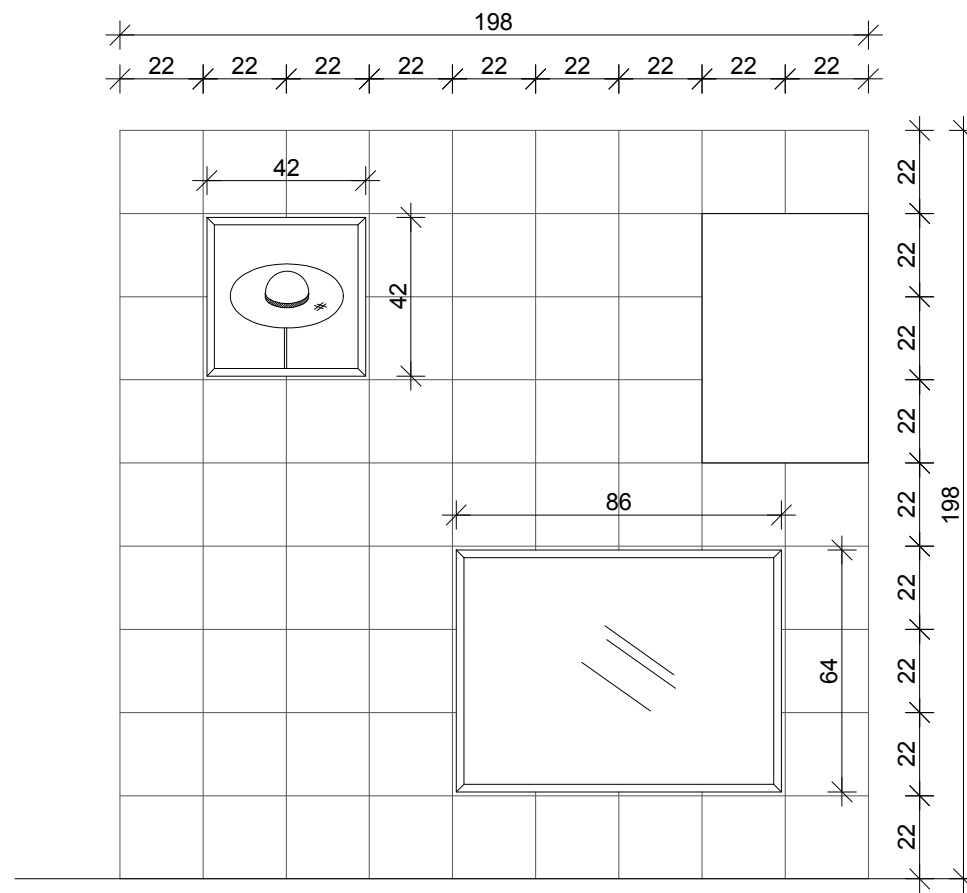

POGLED 3

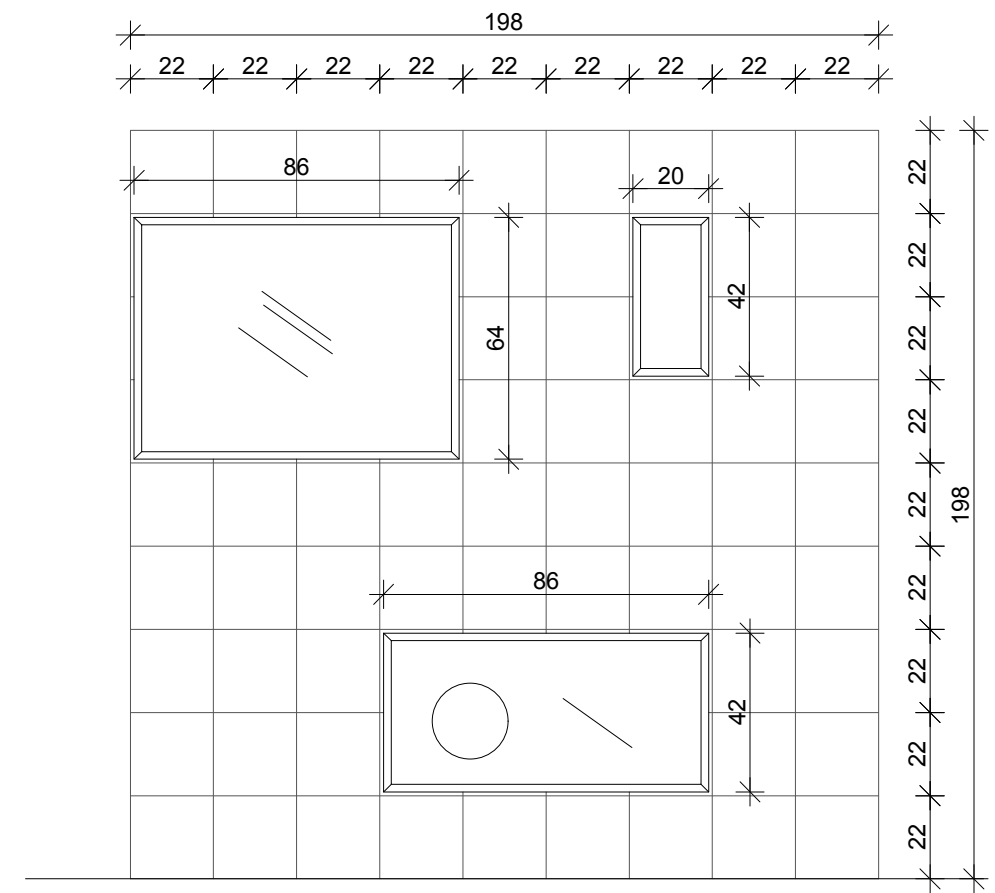

POGLED 4

K. ARH.

K. ARH. d.o.o., za projektiranje i usluge
Baldini 29, 52440 Poreč,
Tel: +386 31 262 940,
e-mail: office@kontra.com
www.kontra.com

Glavni projektant :
Nina Pahović mag.ing.arch.

Projektanti:
Nina Pahović mag.ing.arch.

Suradnici:
Mirjana Lozanovska mag.ing.arch.
Silvija Shaleva mag.ing.arch.
Erik Jurišević abs.arch.

građevina

TRG TRADICIJSKIH OBRTA

lokacija

k.č. 1539 (dio) k.o. Varaždin

investitor

Turistička Zajednica grada Varaždina
Ivana Padovca 3, 42000 Varaždin,

faza

GLAVNI PROJEKT

sadržaj

SHEMA OSREDNJI PROSTOR IZLOŽBE

ZOP / TD :	Mjerilo.	datum:	rev:
002 - A-002	1:20	02.2019	00

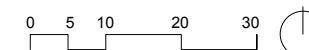

A16

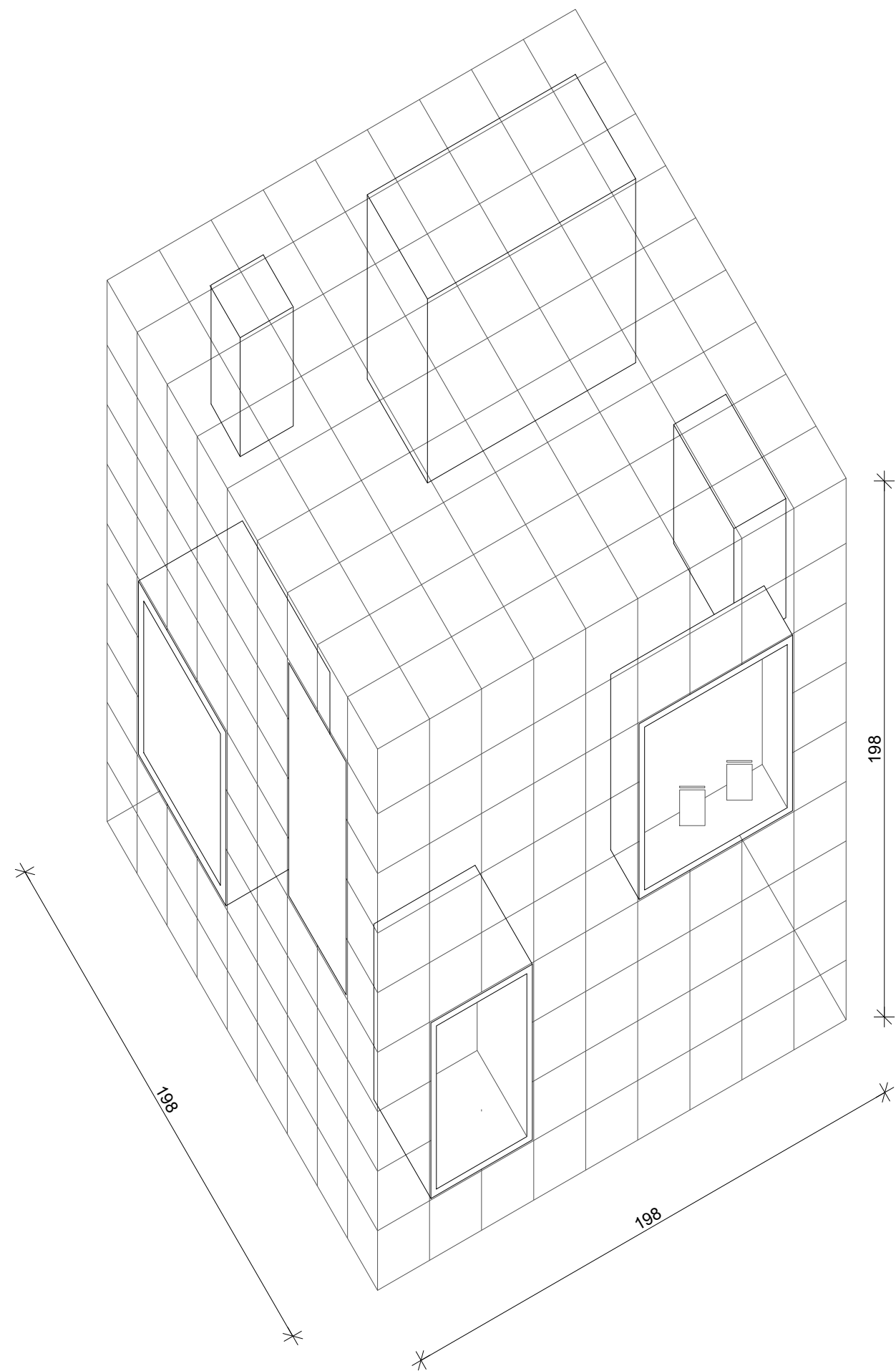

K. ARH.

K. ARH. d.o.o., za projektiranje i usluge
Baldini 29, 52440 Poreč,
Tel: +386 31 262 940,
e-mail: office@kontra.com
www.kontra.com

Glavni projektant :
Nina Pahović mag.ing.arch.

Projektanti:
Nina Pahović mag.ing.arch.

Suradnici:
Mirjana Lozanovska mag.ing.arch.
Silvija Shaleva mag.ing.arch.
Erik Jurišević abs.arch.

građevina

TRG TRADICIJSKIH OBRTA

lokacija

k.č. 1539 (dio) k.o. Varaždin

investitor

Turistička Zajednica grada Varaždina
Ivana Padovca 3, 42000 Varaždin,

faza

GLAVNI PROJEKT

sadržaj

AKSONOMETRIJA: OSREDNJI PROSTOR IZLOŽBE

ZOP / TD :
002 - A-002

Mjerilo:
1:20

datum:
02.2019

rev:
00

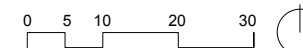

A17